

ADV *BUCK* 125



⚠ WARNING

READ THIS MANUAL CAREFULLY AND COMPLETELY BEFORE OPERATING THIS VEHICLE. THIS OWNER'S MANUAL SHOULD BE CONSIDERED A PERMANENT PART OF THE VEHICLE AND SHOULD REMAIN WITH THE VEHICLE WHEN IT IS SOLD.

ADV BUCK 125

OWNER'S MANUAL

LINHAI CO., LTD

FIRST EDITION, JULY 2024

COPYRIGHT © 2024 ALL RIGHTS RESERVED. THIS PUBLICATION MAY NOT BE REPRODUCED OR TRANSLATED IN WHOLE OR IN PART WITHOUT THE WRITTEN PERMISSION.

This manual should be considered a part of the scooter and should remain with it even if the scooter is subsequently sold. Always keep the manual ready. We have been seeking advancements in product design and quality. Therefore, even when this manual contains the latest production information available at the time of printing, there may be minor discrepancies between your scooter and this manual. If you have any question concerning this manual, contact your Linhai dealer.

FOREWORD

Congratulations on your purchase of new Linhai ADV Buck 125 scooter. This model conforms to the latest international emission standards, and meets the demands for the development of the modern society. This model is the result of Linhai's vast experience in the production of scooters and sport, racing and touring motorcycles. Please read this manual carefully to enjoy all the benefits of your scooter. This manual will give you an understanding of the operation, inspection and basic maintenance of the scooter. If you have any questions about the operation or maintenance of your scooter, contact your Linhai dealer. Ignoring the safety instructions in this manual, safety notices and good driving practices could result in accidents, serious injuries or death;

Always use original Linhai parts and accessories.

This publication includes the latest production information available in time of printing. LINHAI Power Machinery Group Co., Ltd. reserves the right to modify this model and this manual without prior notice and without incurring any obligation. Some information and images in this manual are for reference only. Features and equipment in this manual may vary differ from your actual product.

▲ NOTE

Some images are for illustration only. Your scooter may vary.

This manual uses the following symbols and terms to identify particularly important information:

⚠ DANGER

The Safety Alert Symbol indicates an imminently hazardous situation which, if not avoided, WILL result in death or serious injury.

⚠ WARNING

Failure to follow WARNING instructions COULD result in severe injury or death to the vehicle operator or others.

⚠ NOTICE

Indicates special precautions that must be taken to avoid damage to the vehicle or moderate injury to the rider(s).

⚠ NOTE

A NOTE provides key information to make procedures easier or clearer.

WARNING LABELS

Warning labels on the scooter warn you of potential hazards that could cause serious injury or they provide important safety information. Read these labels carefully and don't remove them.

Warning label on central panel:







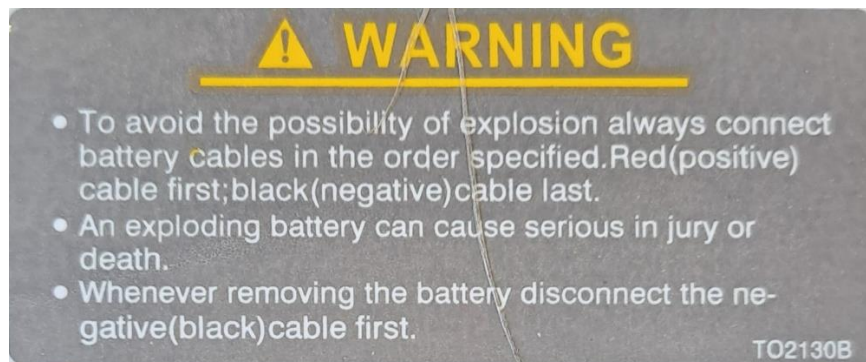



For the sake of your safety and that of other people, please read the operation and maintenance manual carefully before operating your motorcycle.



Warning label on battery cover:

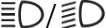

- To avoid the possibility of explosion always connect battery cables in the order specified. Red (positive) cable first; black (negative) cable last.
- An exploding battery can cause serious injury or death.
- Whenever removing the battery, disconnect the negative (black) cable first.

CONTENT

| | | | |
|--|----|--|----|
| CONTENT..... | 6 | Replacing the Key Fob Battery..... | 19 |
| IMPORTANT SAFETY INFORMATION..... | 10 | Indicators and Warning Lights..... | 20 |
| DESCRIPTION..... | 13 | ABS Indicator  | 20 |
| Left View..... | 13 | Traction control (TCS) indicator  | 20 |
| Right View..... | 14 | Engine temperature warning light  | 21 |
| Meters and Controls..... | 15 | EFI lamp..... | 21 |
| VEHICLE IDENTIFICATION | 16 | High beam lamp  | 21 |
| Vehicle identification number..... | 16 | Turn signal lamp  | 21 |
| Engine serial number..... | 16 | Fuel gauge | 21 |
| PARTS AND THEIR FUNCTIONS..... | 16 | HANDLEBAR SWITCHES | 22 |
| Main switch / Steering lock | 16 | Left Handlebar Switches..... | 22 |
| Main switch positions:..... | 16 | Right Handlebar Switches..... | 22 |
| FUEL / SEAT | 17 | Display operation buttons..... | 23 |
| Remote Keyless Entry / Backup Key..... | 17 | UP Button..... | 23 |
| Key Fob..... | 17 | DOWN Button | 23 |
| Key Fob with keyless system..... | 17 | BACK Button..... | 23 |
| Vehicle search button..... | 18 | SET Button | 23 |
| Alarm button - | 18 | Pass Switch (PASS)..... | 23 |
| Keyless Unlock / Lock button  | 18 | High / Low Beam Switch  | 24 |
| Backup key | 19 | Turn Signal Switch  | 24 |

| | |
|---|----|
| Horn  | 24 |
| Engine Stop Switch | 24 |
| Hazard Switch  | 24 |
| START Button  | 24 |
| Rear brake lever | 25 |
| Front brake lever | 25 |
| USB Socket | 25 |
| ABS System | 26 |
| Fuel tank cap | 27 |
| Open the fuel tank | 27 |
| Close the fuel tank | 27 |
| Fuel | 27 |
| Refueling: | 27 |
| Seat | 28 |
| Open the seat | 28 |
| Close the seat | 28 |
| Driver's floorboard | 28 |
| Passenger footrests | 28 |
| Helmet hooks | 29 |
| Hang the helmet on the hooks: | 29 |

| | |
|--|----|
| Take the helmet off the hooks: | 29 |
| Front storage compartment | 29 |
| Underseat storage compartment | 30 |
| Rear suspension | 31 |
| Side stand | 31 |
| Center stand | 32 |
| Exhaust emission control system | 32 |
| Catalytic converter | 32 |
| Oxygen sensor | 33 |
| PRE-RIDE INSPECTION | 35 |
| BASIC OPERATION AND RIDING | 37 |
| Starting the engine | 37 |
| Starting control | 37 |
| Accelerating and decelerating | 37 |
| Braking | 38 |
| Fuel-efficient driving tips | 38 |
| Engine break-in | 38 |
| Parking | 40 |
| PERIODIC MAINTENANCE AND MINOR REPAIRS | 41 |
| Tool kit | 42 |
| Spark plug inspection | 42 |

| | | | |
|--|----|---|----|
| Spark plug removal..... | 42 | Wheels..... | 51 |
| Spark plug inspection..... | 42 | Front/Rear brake inspection..... | 52 |
| Spark plug installation:..... | 43 | Front /Rear brake pad inspection..... | 52 |
| Engine oil and oil strainer..... | 44 | Brake fluid inspection..... | 53 |
| Engine oil level inspection..... | 44 | Brake fluid maintenance:..... | 53 |
| Engine oil change..... | 45 | Brake fluid replacement..... | 53 |
| Final Drive oil..... | 45 | Cables inspection and lubrication..... | 54 |
| Final drive oil change..... | 45 | Throttle grip and cable inspection and lubrication..... | 54 |
| Coolant..... | 46 | Front and rear brake lever lubrication..... | 54 |
| Coolant level inspection..... | 46 | Center and side stand inspection and lubrication..... | 55 |
| Coolant replacement..... | 48 | Front fork inspection..... | 55 |
| Main air filter and V-belt air filter..... | 48 | How to check..... | 55 |
| Main Air Filter Element Change..... | 48 | Steering inspection..... | 56 |
| Clean Air Filter Box Sediment Tube..... | 48 | Wheel bearing inspection..... | 56 |
| Clean V-belt Air Filter Element..... | 49 | Battery..... | 57 |
| Throttle grip free play inspection..... | 50 | Battery charging..... | 58 |
| Valve clearance adjustment..... | 50 | Battery storage..... | 58 |
| Tires..... | 50 | Fuse..... | 59 |
| Tire pressure..... | 50 | Fuse replacement..... | 59 |
| Tread Wear..... | 51 | OBD connector..... | 59 |
| Tires..... | 51 | LED Headlight lamp replacement..... | 60 |

| | |
|--|----|
| LED Turn signals/Tail/Brake/Position light replacement ... | 60 |
| Rear view mirrors..... | 60 |
| Troubleshooting..... | 61 |
| Troubleshooting chart..... | 62 |
| 1. Fuel | 62 |
| 2. Compression..... | 62 |
| 3. Ignition | 62 |
| 4. Battery..... | 62 |
| CLEANING AND STORAGE | 63 |
| Cleaning..... | 63 |
| Washing the scooter: | 63 |
| Cleaning after normal riding..... | 63 |
| Cleaning after riding in rain, winter or near the sea..... | 64 |
| After cleaning..... | 64 |
| Storage..... | 65 |
| Short-term storage..... | 65 |
| Long-term storage..... | 65 |
| SPECIFICATIONS | 66 |
| Vehicle identification..... | 69 |
| Vehicle Identification Number | 69 |
| PERIODIC MAINTENANCE CHART..... | 70 |

IMPORTANT SAFETY INFORMATION

⚠ DANGER

- This scooter is not a toy and can be dangerous. Be careful when driving or performing maneuvers.
- Read this manual carefully to know all the functions and features of your scooter.
- Know your limits and the limits of your scooter.
- Never drive under the influence of alcohol, drugs or medications.
- Always wear an approved helmet. Most deaths on motorcycles, scooters and mopeds are because of head injuries. Wearing a helmet is essential to prevent and reduce severity of these injuries.
- Always wear gloves, long pants and protective bright color clothing that protects your hands, arms, legs, ankles and feet. Never wear loose clothing that could get caught on the levers, footrests, wheels, handlebars, etc.
- Passengers must also respect these precautions.
- Before starting the engine, make sure you have pressed one of the brake levers with throttle completely closed.
- Excessive speed increases the risk of losing control of the scooter. Never drive faster than road, traffic and visibility conditions allow. Be aware weather conditions may negatively affect your driving (wind, rain, fog, etc.).
- Accelerate and brake gently to avoid risk of losing control of the scooter.
- Ride defensively.
- Be prepared to stop quickly or perform an evasive maneuver.
- For best braking effectiveness, use both the front and rear brakes together.
- This model equipped with an Anti-lock Brake System (ABS) on each wheel, designed to help prevent the brakes from locking up during hard braking. However remember, that the ABS system cannot prevent accidents caused by excessive speed, driving recklessly, following too closely or on slippery surfaces. It is important to drive safely and attentively to prevent accidents.
- ABS does not function at speeds below 10 km/h.
- When driving, make you visible to others, either by your positioning on the road, or by wearing bright reflective clothing.
- Always give a turn signal before turning or changing direction or lanes. Make sure others see you.
- The turn signals do not turn off automatically at the end of the maneuver. Return turn signal switch to its central position so as not to confuse other drivers.

- Use hazard lights when you need to alert others of a possible danger, such as a traffic jams, accident or temporary parking.
- Never carry more than one passenger and make sure he/she has the necessary knowledge about how to ride on the scooter.
- Passenger must sit on passenger seat.
- Never carry a passenger who is not able to place both feet on the footrests.
- During the ride always maintain control of the vehicle. The driver must keep both hands on the handlebars and both feet on the floorboards.
- Always try to avoid emergency braking on wet roads as it can be extremely dangerous. Brake gently on wet or icy surfaces.
- Always slow down when approaching corners and intersections, or when crossing road junctions.
- Exercise extra caution when passing stationary vehicles. Their occupants may not see the scooter and open the car doors suddenly.
- Road plates and covers, tramway rails, potholes, white road markings, covers on building sites are slippery when wet. Therefore, always slow down and go across them carefully. Make sure to keep scooter upright as much as possible to avoid falling over.
- Do not perform any type of dangerous maneuvers, such as jumps, wheelies, curves at excessive speed, burnouts and others
- Always check the brakes for proper function before the ride. Braking performance may be reduced after the washing.
- Park the scooter on solid and preferably flat surface to avoid fall.
- Never overload the scooter. Carrying extra weight affects your scooter's handling, braking and stability. Overloading or improper loading can cause a crash and you can be seriously hurt or killed. Refer to "Tire" section.
- Make sure the load is securely tied to the scooter. Shifting load weight during the ride can create sudden instability and distract your attention from the road situation.
- Increase braking distance and reduce speed when transporting loads. Keep the load as low as possible. Loads that are too high can interfere with the vehicle's center of gravity and reduce its stability.
- Do not transport animals.
- Avoid leaving the scooter idling for too long.
- Your scooter has several components that can be hot when driving and after ride (exhaust, engine, brake discs etc.). Avoid contact with these components immediately after stopping the scooter.
- Whenever you lift or remove the seat, check that seat is securely closed before ride.

- Make sure the storage compartments are securely closed. Do not store fragile, heavy or flammable objects inside the compartments.
- Always use the tires (size and type) specified in this manual.
- Always use the correct fuel for your scooter.
- Always use the oils, lubricants and coolants recommended by the manufacturer.
- Always check items such as brakes, steering, tire pressure, fuel, engine oil and rear view mirrors before every ride.
- Do not modify the scooter in order to increase speed or change the riding characteristics. Modifications and components that alter manufacturer's specifications can make your scooter unsafe, void your warranty and make the scooter illegal for use on public roads.
- Removing or modifications of lights, exhaust and intake system, emission control system and other vital systems can also make your scooter illegal.
- Gases emitted by the engine are potentially toxic and should not be inhaled. Do not run the engine in closed spaces.
- Never fill the fuel tank completely. Leave a space for gasoline to expand due to temperature increase.
- Any alteration to, or manipulation with the frame number, engine number or vehicle registration number is prohibited.
- Installation of non-original accessories or non-approved alterations to the vehicle may invalidate the warranty. Modifications to the bodywork, engine or scooter characteristics may expose you and others to risk of accident and death. You are responsible for any accidents that may occur as a result of alterations made to the vehicle. Never install accessories that could compromise vehicle's performance. Accessories fixed to the handlebars or in the front fork area can create instability due to poor weight distribution or alterations of the aerodynamics. When attaching accessories to the handlebars or front fork remember that they should be as light as possible. Large or bulky accessories can seriously impair stability of the scooter, as they can cause aerodynamic instability.
- Linhai does not approve or recommend use of non-original accessories that would change the design or original characteristics of the vehicle, even when they have been sold and installed by an official dealer.
- Installation of electrical accessories requires special attention. If power draw of these accessories exceeds capacity of vehicle's electrical system, it may cause sudden breakdowns, loss of lighting or engine power. The use of electrical accessories may decrease the life of the battery.
- If any warning label on the scooter comes off or becomes hard to read, contact your Linhai dealer for replacement.

Failure to follow these warnings increases the possibility of accident and, consequently, serious injury and death.

DESCRIPTION

Left View

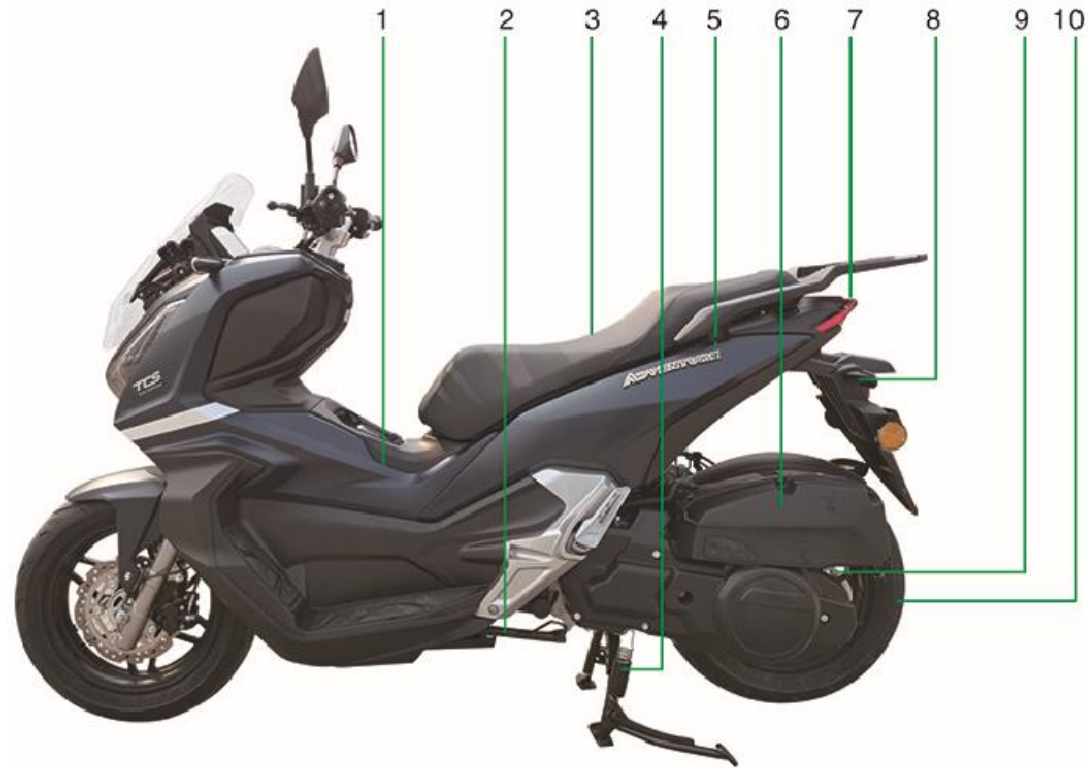

1. Fuel tank
2. Side stand
3. Seat
4. Center stand
5. OBD interface

6. Air filter
7. Tail light / Brake light
8. Rear turn signal
9. Final drive oil filler cap
10. Rear wheel

Right View

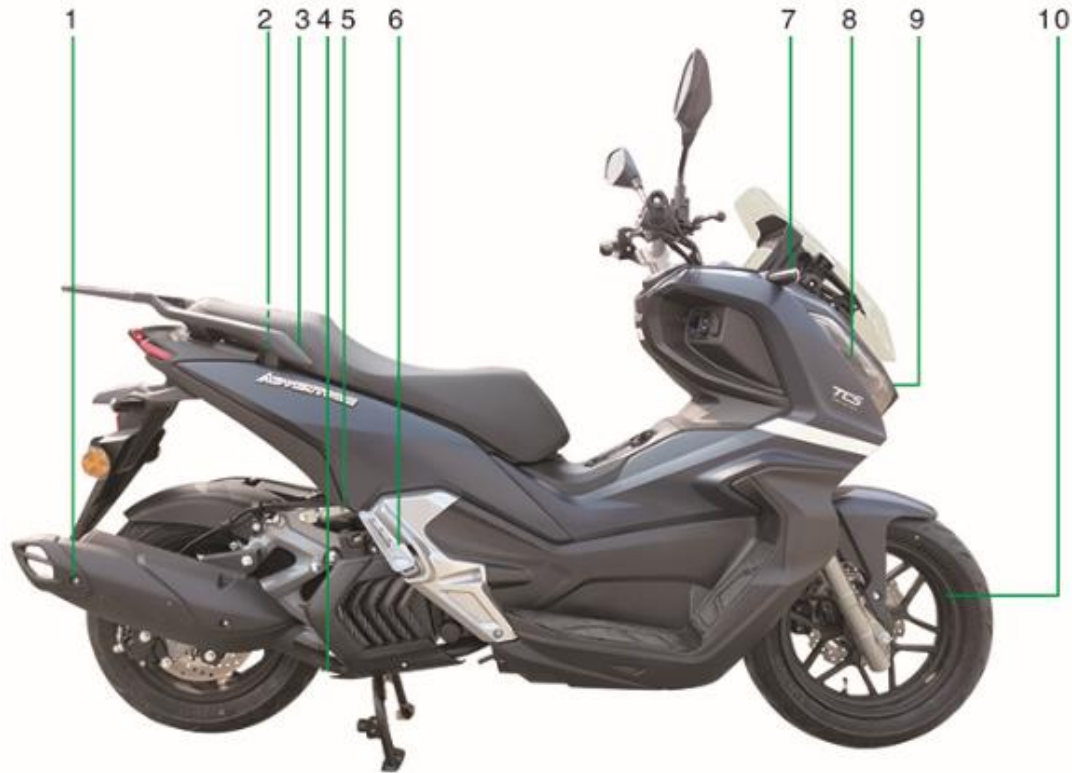

1. Exhaust muffler
2. Battery
3. Underseat compartment
4. Engine oil filler cap
5. Rear suspension

6. Passenger footrest
7. Front turn signal
8. Position light
9. Headlight
10. Front wheel

Meters and Controls

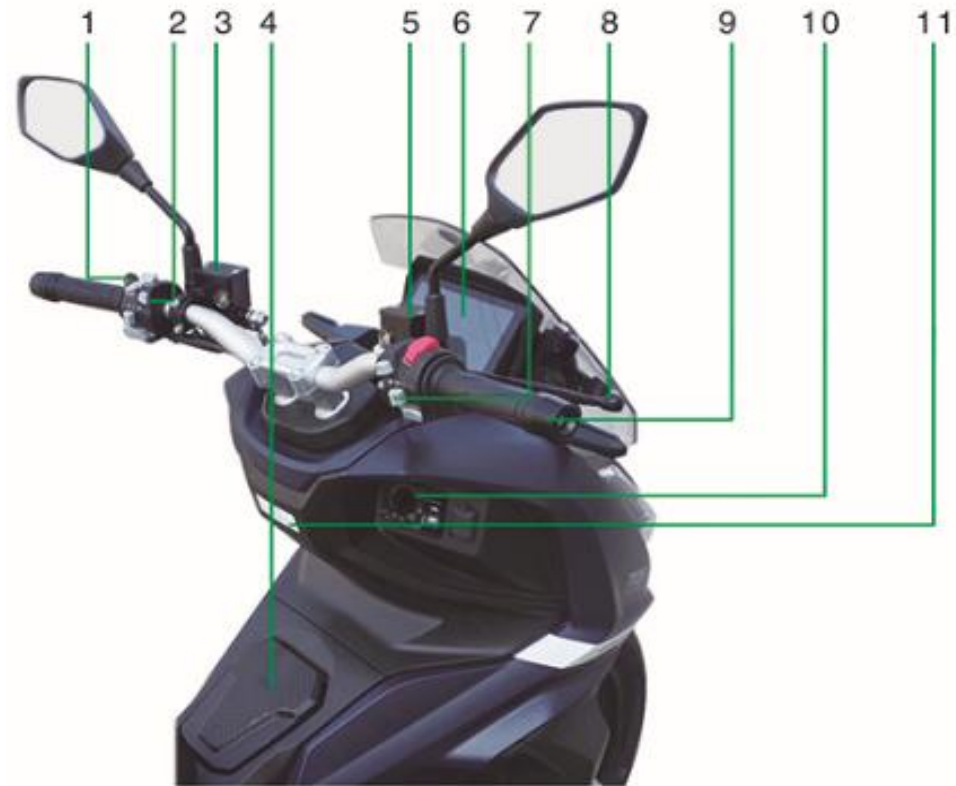

1. Rear brake lever

2. Left handlebar switch

3. Rear brake master cylinder

4. Fuel tank cap

5. Front brake master cylinder

6. Instrument panel / LCD display

7. Right handlebar switch

8. Front brake lever

9. Throttle grip

10. Main switch/Steering lock

11. Front storage compartment

VEHICLE IDENTIFICATION

Vehicle identification number

The vehicle identification number is located on the rear center section of the frame.



Engine serial number

The engine serial number is located at the upper rear of the left crankcase.



PARTS AND THEIR FUNCTIONS

Main switch / Steering lock

Main switch/ Steering lock controls the ignition and lighting systems, and locks the steering. After you unlock the scooter (either by pressing Key Fob Unlock Button or by keyless unlocking), for 5 seconds you can operate this switch manually to the desired position.

⚠ NOTE

Main switch / Steering lock is equipped with a keyhole protective cap to insert Backup Key. (Refer to page 19)

Main switch positions:

“**i**” (ON): In this position all electrical systems are on, and the engine can be started.

“**O**” (OFF): In this position all electrical systems are off

„**🔒**“ (LOCK): In this position the steering can be locked, and all electrical systems are shut off. The key can be removed.

FUEL / SEAT

In this position you can press the square button on the right to electrically open the fuel tank lid or seat.



⚠ WARNING

When the scooter is moving, do not turn the main switch to “O” or “🔒” positions. All electrical circuits would get switched off, which would cause the scooter to get out of control, resulting in an accident.

Remote Keyless Entry / Backup Key

Allows you to remotely unlock the steering, switch the ignition on, and start the scooter remotely with a press of a button.

Key Fob

Your scooter comes with two key fobs with backup key inside.



Key Fob with keyless system

Allows you to remotely unlock the steering and ignition switch, and start the scooter without pressing any key fob button.

This function is active by default whenever you start the vehicle. To deactivate the function, with the ignition in a position other than “O”, press and hold the unlock button for 2 seconds and the proximity unlock function will be deactivated. Press and hold again to reactivate it.

Vehicle search button

When parking the scooter, press the search button. The system will beep 3 times, and simultaneously the turn signal lights will flash 3 times, informing the owner about the vehicle's location.

Holding the search button for a long time (app. 10 seconds) temporarily deactivates the vehicle alarm sound and the scooter only flashes. However, when the ignition is switched on again next time, the acoustic alarm function is resumed. When the alarm is active, press the vehicle search button once to pause the alarm.

Alarm button -

Alarm activation: With the ignition in "O" position, press the alarm button once, the system beeps once and the turn signals will flash once. The alarm function also activates automatically 30 seconds after the ignition is switched to the "O" or "🔒" position. Alarm can only be activated when the ignition is in "O" or "🔒" position (handlebars are locked).

Keyless Unlock / Lock button

Your scooter is equipped with a keyless steering locking function. If you use a key fob with the "" button, and the remote control is within a range of 1.2 m from the scooter, the scooter can be unlocked and activated remotely.

If you use a key fob with "" button, press the manual ignition switch to activate the system and for 5 seconds the switch can be turned to positions "i", "FUEL / SEAT", "O", "🔒".

Also keep in mind the following:

- If the ignition switch is in the "i" (On) position, the key fob buttons are not active.
- Effective vehicle detection distance is approximately about 1.2 m depending on the battery status.
- The maximum operating distance of the remote control is approximately 100 meters (in areas without obstacles and interference).
- Smart lock system current draw in standby mode is approximately 2 mA.
- The keyless system has protection against high voltage (Over current protection).

Backup key

If the keyless unlock function fails, due to for example low battery or electrical failure, you can use the backup key ① located inside the key fob to operate the vehicle. Insert Backup key into the centre slot in the Manual ignition switch and turn it 180 degrees. This will activate the Main Switch. Turn the Manual Ignition Switch to SEAT/FUEL position to unlock the seat or the fuel tank cap, or to "i" / On position and you can start the engine.



Backup key

Replacing the Key Fob Battery

If the Key Fob indicator flashes 5 times when the ignition switch is turned On, or the operating range becomes shorter, replace the Key fob battery as soon as possible. We recommend to see your dealer for this service.

Battery type: **CR2032**

1. Remove the upper case by inserting a coin or a flat head screwdriver covered with a protective cloth into the slit.
2. Replace the old battery with a new battery with the negative side facing up.
3. Snap the two halves of the key fob back together. Make sure that upper and lower cases are set in the right position.

⚠ WARNING

Do not swallow battery. If swallowed, the battery can cause severe internal burns and even death.
Keep battery away from children.
Keep battery compartment securely closed.
Immediately seek medical attention if a child may have swallowed battery.

Indicators and Warning Lights



1. Traction control indicator
2. Engine malfunction warning
3. ABS indicator
4. Engine temperature warning
5. High beam indicator
6. Turn indicator

ABS Indicator

Under normal conditions, the ABS indicator will come on whenever the key is in "ON" position, and will turn off when the vehicle speed exceeds 10 km/h.

If the ABS indicator light does not come on when the key is turned to "ON", or stays on or flashes while riding, or ABS indicator remains on after the speed exceeded 10 km/h, ABS is not working properly. Contact authorized Linhai dealer for inspection.

NOTE

When the scooter stands on center stand and the engine is revved, ABS indicator will come on. In this case this does not indicate a faulty ABS system. When in this situation, turn off and then turn on the main switch to reset the warning light

Traction control (TCS) indicator

After the scooter is switched on, the Traction control (TCS) indicator will flash and will turn off as soon as you start driving. Traction control can be turned off in the display settings. If you disable the TCS system, the TCS indicator will remain on permanently. Each time you start the scooter, the traction control automatically resets and will be active again. When the traction control is on (active), in the event of rear wheel slips, the traction control will actively reduce engine torque to reduce rear wheel slip. When traction control is actively working, the TCS indicator is flashing rapidly.

WARNING

If the TCS indicator remains on when traction control is working, it indicates a malfunction of the TCS. Contact Linhai an authorized service as soon as possible.

WARNING

If the ABS indicator does not come off when speed exceeds 10 km/h, or if the indicator light comes on up or flashes while driving, the ABS system is disabled and the system will return to standard non-ABS braking. If both these situations occur, or if the ABS indicator light does not come on at all, ride extremely carefully to avoid the possibility of wheels locking up during emergency braking. Contact authorized Linhai service as soon as possible.

Engine temperature warning light

This warning light will come on when the coolant temperature is excessive (engine is overheated). If this happens, park the scooter in a safe place, turn off the main switch and let the engine cool down. When the engine is cooled, check the coolant level and add more if necessary, then turn the main switch on. The warning light should come on for a few seconds and then should come off. If the problem persists, contact authorized Linhai service.

EFI lamp

This light comes on when the diagnostic system detects a fault with the engine or the vehicle's control system. Contact authorized Linhai service immediately.

High beam lamp

This indicator turns on whenever the high beam is on.

Turn signal lamp

The corresponding indicator (left or right) on the dashboard flashes if you activate the turn signals. When the hazard lights are activated, both indicators (left and right) come on.

Fuel gauge

The fuel gauge indicates the amount of gasoline in the engine. As gasoline in the fuel tank is consumed, the number of bars gradually decreases from "F" (Full tank) to "E" (Empty tank). If the fuel warning light "" starts flashing, it indicates that there is low fuel in the tank. Refuel as soon as possible. Never allow the tank to be completely empty.

WARNING

When fuel warning light "" starts flashing, refuel as soon as possible. Due to the movements of gasoline remaining in the fuel tank while braking, riding uphill / downhill or cornering, the engine may stall due to the inability to supply enough fuel.

HANDLEBAR SWITCHES

Left Handlebar Switches

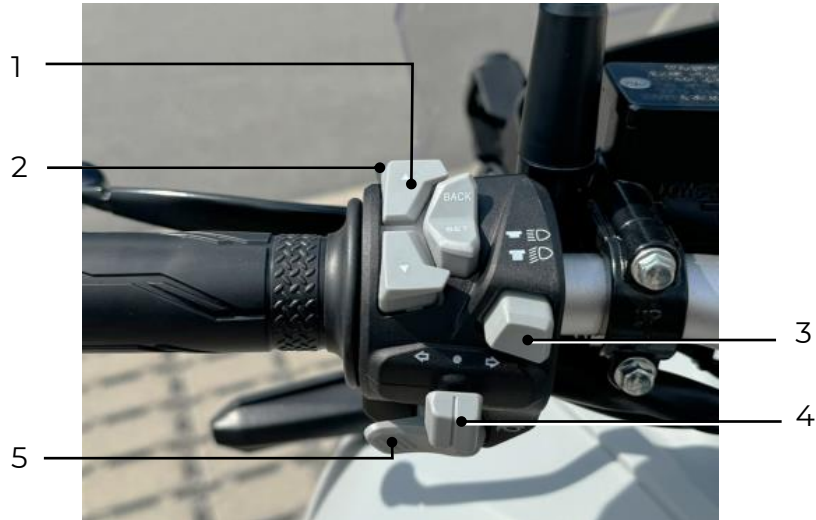

1. Display operation buttons
2. Pass switch
3. High / Low beam switch
4. Turn signal switch
5. Horn

Right Handlebar Switches



6. Engine stop switch
7. Hazard signal
8. Electric start button
9. Throttle grip

Display operation buttons

UP Button

Press and hold for 3 seconds to change between metric and imperial units.
Short press to set the hours, increasing the hours reading by one (1). When not in clock setting mode, use this button to change display brightness (5 levels).



DOWN Button

Press and hold for 3 seconds to reset the odometer to zero.
Short press to set the minutes, increasing the minutes reading by one (1).

BACK Button

Press and hold for 3 seconds to set the clock. The hours and minutes will flash and can be changed by pressing the “Up” or “Down” buttons. When flashing, press the “Up” button to increase the setting. Press and hold again to exit the settings, or wait 10 seconds to exit clock setting mode automatically.

SET Button

Press and hold for more than 3 seconds to disable the traction control function. The TCS warning light will flash indicating that the ECU has disabled the TCS function. When normal driving, the TCS warning light on the display will remain on, indicating traction control is disabled. When the scooter is restarted, the traction control function will be activated again.



Pass Switch (PASS)

Press the switch to flash the headlights high beam.

⚠ WARNING

Use the pass switch reasonably so you do not affect other road users.

High / Low Beam Switch

Move the switch (3) to “D” position to activate the high beam, and to “D” position to activate the low beam.

Turn Signal Switch

Move the switch (4) to the right to activate the right turn signals and to the left to activate left turn signals. The switch will return to the central position when released. To cancel the turn signals, push the switch in the center position inward.

Horn

Press the “” switch (5) to sound the horn.

Engine Stop Switch

The engine stop switch (6) is used to stop the engine in an emergency. To stop the engine, push the switch to the OFF position. The switch must be in the RUN position to start the engine. If the engine is stopped using the engine stop switch, be sure to move the engine stop switch again to RUN position - the engine stop switch must be in the "RUN" position for the engine to start and operate.

NOTE

Although the engine stop switch stops the engine, it does not turn off all the electrical circuits. If the scooter is stopped with the ignition switch ON and the engine stop switch OFF, the taillight and license light will remain on, resulting in battery discharge.

Hazard Switch

Press the Hazard switch and the front and rear flashers will flash simultaneously. Use the hazard lights whenever you need to alert other drivers of possible danger, such as traffic jams, accidents or emergency parking.

NOTICE

Leaving the hazard lights on for an extended period of time can drain the battery power out.

START Button

Pull the front or rear brake lever, and press the START switch to start the engine. The electric starter will only work when the front or rear brake lever is pulled in and the side stand is up.

Rear brake lever

Rear brake lever is located on the left handlebar. Pull the lever toward the handlebar to activate the rear brake.

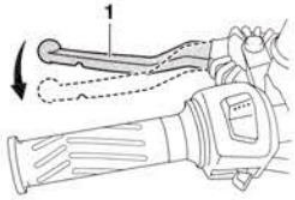

Front brake lever

Front brake lever is located on the right handlebar. Pull the lever toward the handlebar to activate the front brake.

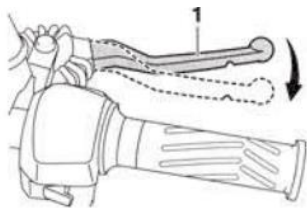

USB Socket

A USB socket (1) is provided at the left side of the instrument panel. Its USB-A type socket with output of 5V/2A.

This socket can charge electronic devices through USB connection. There is a cover lid on the socket to protect the socket from dust, sand, etc.

⚠ NOTICE

Using the USB socket while the engine is idling or stopped may drain the battery. Be aware of battery drain when using the USB socket.

⚠ NOTICE

Failure to observe the following items when handling the USB socket may result in damage to the motorcycle or connected devices. • Do not connect any electronic device other than a mobile phone. • Do not use when washing the motorcycle or when it is raining. Pull out the USB cable and attach the cap.

⚠ NOTE

When not using the USB socket, attach the cap to prevent foreign materials from entering it.

ABS System

The ABS (Anti-lock Braking System) on this scooter uses dual electronic control system which can operate front and rear brake separately. The way how you brake on a scooter with ABS is the same, how you brake with vehicles without ABS. Whenever the ABS is activated, you will feel vibrations in the brake lever. Continue braking to allow the ABS system to work. Do not “pump” the brake lever by repeatedly releasing and then reapplying the brake lever as this will negatively affect the braking ability of the scooter.

⚠ WARNING

ABS is controlled by the ECU, which will disable the ABS system in case of ABS malfunction. When this happens, brake system will return to standard non-ABS braking.

⚠ WARNING

Even if the vehicle has an ABS braking system, the speed and braking distance must be adapted to the road, traffic, and other conditions.

⚠ NOTE

Every time the key is turned to "ON", the engine is started, and the speed exceeds 10 km/h, ABS system will perform a self diagnostic test.

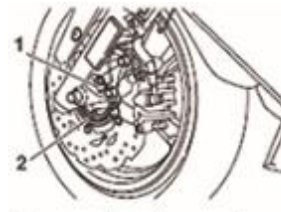

1. Front wheel speed sensor
2. Front ABS tone ring

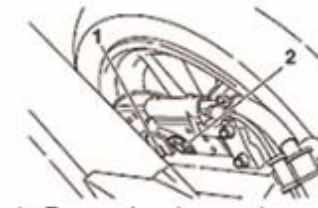

1. Rear wheel speed sensor
2. Rear ABS tone ring

Fuel Tank Cap

Open the Fuel Tank

Rotate the manual ignition switch to FUEL / SEAT position and press the FUEL button to open the fuel tank lid.

Close the Fuel Tank

To close the fuel tank, push the cap back to its original position. Make sure fuel tank cap is securely closed.

⚠ WARNING

Be sure the tank lid is properly installed and locked before riding to avoid the fuel to leak, which may cause fire.

Fuel

Only use unleaded 95 octane gasoline (E10).

Fuel tank capacity: 12 L

Refueling:

1. Stop the engine.
2. Avoid all sources of fire. Do not smoke.
3. When refueling, insert the entire fuel nozzle into the tank.

4. Do not overfill the tank. When heated (the heat can come from engine or sunlight), gasoline expands and may spill out from the tank.

5. Be sure not to pour gasoline onto a hot engine.

6. Use a clean, dry cloth to wipe up any spilled fuel on the scooter. Gasoline can damage painted surfaces and plastic parts.

7. Make sure the fuel tank cap is securely closed when you finish refueling.

⚠ WARNING

Gasoline is harmful, flammable and explosive, and can cause injury or death. Be cautious when dealing with fuel. Do not siphon gasoline with your mouth. If you accidentally swallow fuel, or inhale too much fuel gases, or when fuel splash in the eye, seek medical assistance immediately. If fuel spills on your skin or clothing, immediately wash it off with soap and water and change the clothing,

Seat

Open the seat

Rotate the manual ignition switch to FUEL / SEAT position and press the SEAT button to open to open the seat and the trunk underneath

Close the seat

1. Push the seat down until you hear a click indicating the seat is properly closed. Make sure the seat is securely locked.
2. If you are leaving the scooter, take out the key from the main switch.

⚠ NOTE

Before the ride, make sure the seat is locked.

Driver's floorboard

Your scooter is equipped with a floorboard for the driver (1), which is intended for the driver's feet to place.

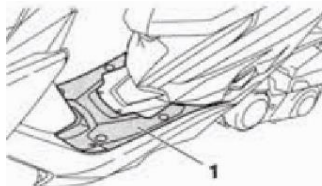

1. Drivers floorboard

⚠ WARNING

Make sure the driver's feet are always on the floorboard when driving.

Passenger footrests

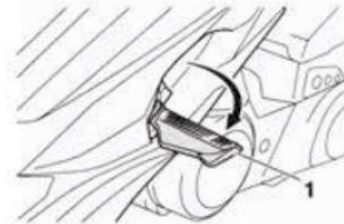

This scooter is equipped with passenger footrests on both sides of the vehicle. Passenger must keep his/her feet on the footrests while the vehicle is moving. Retract the footrests when not in use.

Helmet hooks

When you open the seat, you will find two helmet hooks that you can use to hang your helmets and then close the seat to secure them. Check that the helmets are securely fastened before leaving the vehicle.

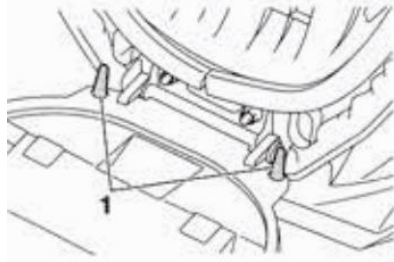

Hang the helmet on the hooks:

Open the seat, hang the helmet(s) on the hook(s), and then close the seat.

Take the helmet off the hooks:

Open the seat and take the helmet(s) from the hooks. Close the seat.

⚠ WARNING

Do not ride with the helmet(s) hanging on the hook(s). Helmet can hit other objects which can make your vehicle to lose control, causing an accident.

Front storage compartment

Your scooter is equipped with two storage compartments: one in the front of the scooter, under the handlebars, and the other in the trunk, under the seat.

Maximum weight limit 1,5 kg.

⚠ WARNING

- Do not exceed the maximum loading limit of the scooter: 150 kg.
- Do not install accessories or carry loads that might interfere with the movement of the handlebars.
- Overloading may lead to dangerous situations when objects fall off while riding.



Underseat storage compartment

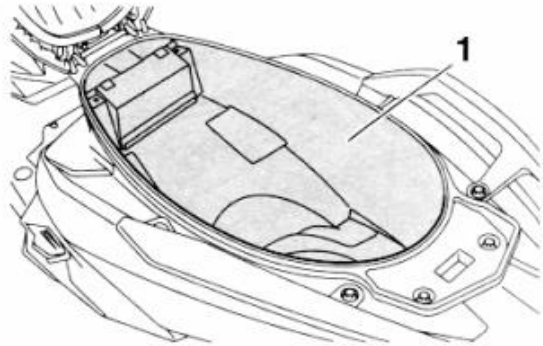

⚠ WARNING

Maximum weight limit: 5 kg
Total weight limit of the vehicle: 150 kg
·Overloading may lead to dangerous situations when objects fall off while riding.

⚠ WARNING

When using the underseat compartment, keep following in mind:

- Underseat compartment may become heated due to the sun or heat coming from engine.
- Do not store food and other items which are flammable or susceptible to heat damage in this compartment.
- Do not direct water under pressure against the center compartment as water will be forced into the compartment.
- Before washing the vehicle, remove all items from the underseat compartment. To protect from moisture, you can pack items into a plastic bag before putting them into the underseat compartment.
- Do not store flammable liquids, fragile objects, or objects that could catch fire in the compartment.
- When leaving the vehicle, take all valuables with you and make sure the seat is properly locked.

Rear suspension

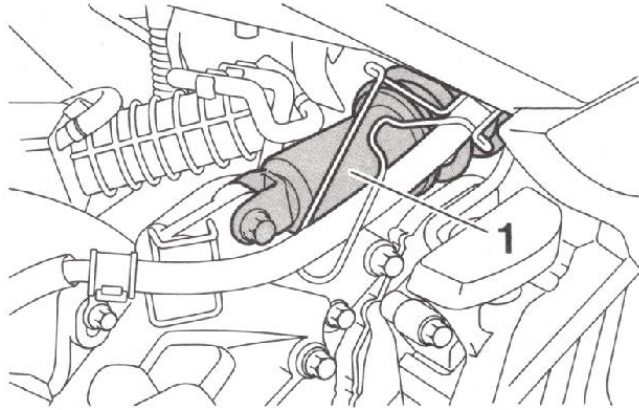

⚠ WARNING

Rear shock absorber contains highly compressed nitrogen gas. Before handling the rear shock absorber, read and understand the following information. The manufacturer cannot be held responsible for property damage or personal injury that may result from improper handling of the shock absorber.

Do not tamper or attempt to open the shock absorber.

Do not subject the rear shock absorber to an open flame or any other source of high heat. High heat can cause an explosion due to excessive gas pressure.

Do not bend, deform or damage the rear shock absorber in any way. Rear shock absorber damage will result in poor damping performance.

Side stand

Your scooter is equipped with a side stand at the lower left side of the vehicle, which you can use to support the scooter when you are not driving.

To lower the side stand, use your foot to guide it down.

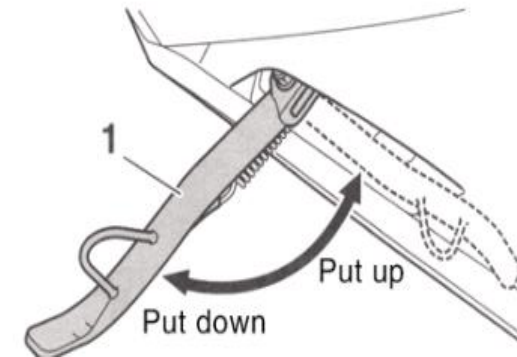

⚠ WARNING

Make sure the side stand is up before riding. Otherwise it can touch the road when riding, which will distract the driver and may cause the scooter to get out-of-control.

If the side stand spring loses tension, the side stand may get loose when riding. Have the weak spring replaced by authorized Linhai service.

Center stand

The center stand is located at the center of the scooter, below the vehicle. To lower the center stand, keep the scooter upright and stand on the left side of the scooter. Hold the left handle grip and the left passenger handrail. Press down on the tip of the stand with your right foot and, simultaneously, pull the scooter up and back.



⚠ WARNING

Make sure the center stand is up before riding, or it can touch the road when riding, which will distract the driver and may cause the scooter to get out-of-control. If the center stand spring loses tension, the side stand may get loose when riding. Have the weak spring replaced by Linhai authorized service.

Exhaust emission control system

Your scooter is equipped with the exhaust gas emission control system to ensure that the exhaust gas emissions

meet the applicable emission standards. Emission control system consists of: catalytic converter, crankcase breather valve

⚠ WARNING

To make sure the exhaust gas emissions meet the emissions standards and to maintain original performance of your vehicle:

1. Do not disassemble, modify or service parts of the exhaust gas control system.
2. Maintain the scooter in accordance with the Owner's manual, specifically according Periodic maintenance chart.

Catalytic converter

The catalytic converter is located in the muffler. Catalytic converter converts the harmful emissions gases into safer ones by chemical reaction.

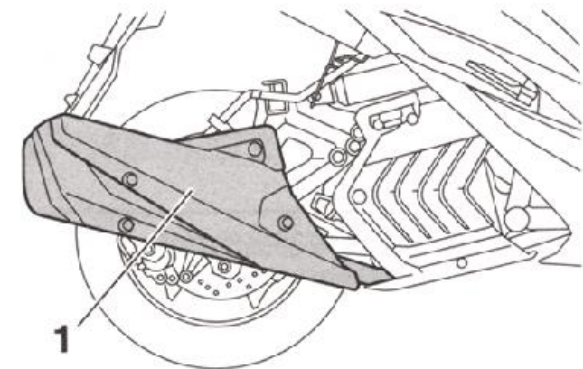

Oxygen sensor

Oxygen sensor (1) in the exhaust system measures oxygen content in exhaust gases.

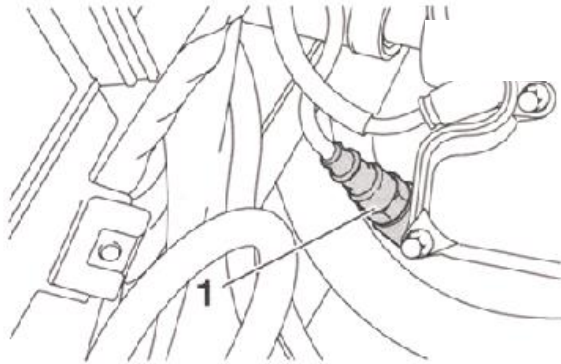

⚠ WARNING

The exhaust system becomes hot after the ride. To prevent risk of fire or burns:

- Make sure flammable materials such as dry grass or leaves do not come in contact with the exhaust system when parking your scooter.
- Park the scooter at the places where the pedestrians and children cannot touch it, so as to prevent burns.
- Make sure the muffler and exhaust system has cooled down before any maintenance work.
- The engine should not run at idle speed for a long time, otherwise it can produce too much heat and cause fire or damage to the exhaust gas emission control system.

⚠ WARNING

- Use only 95 octane unleaded fuel. The use of leaded fuel will damage the catalytic converter.
- Do not switch off the main switch while the scooter is moving, or large amount of unburned gases will get into the muffler and burn there, which will damage the catalytic converter.

PRE-RIDE INSPECTION

To ensure safety, it is your responsibility to perform a pre-ride inspection and make sure that that it is safe to ride. Be sure to check and maintain your scooter according to this manual. Before you get on your scooter, check the following items.

⚠ WARNING

If the scooter is not checked and maintained properly, it will increase the probability of an accident or damage to parts. If you find any problem, stop riding the vehicle. If you cannot find a solution to solve the problem in this manual, contact Linhai authorized dealer for check.

| Item | Check | Page |
|---------------------------|--|-------|
| Fuel | <ul style="list-style-type: none">·Check fuel level. Top up if necessary.·Check if there is any leakage in the fuel hoses. | 13 |
| Engine oil | <ul style="list-style-type: none">·Check engine oil level. Add oil if necessary.·Check if there is any leakage. | 24~25 |
| Final drive oil | <ul style="list-style-type: none">·Check if there is any leakage. | 26 |
| Coolant | <ul style="list-style-type: none">·Check if there is any leakage. Add the recommended coolant to the specified level if necessary. | 27 |
| Front brake Rear brake | <ul style="list-style-type: none">·Check the brake operation.·If the brake feels loose and soft, ask Linhai dealer to bleed air from hydraulic system.·Check brake pads wear; change if necessary.·Check the brake fluid level in the master cylinder, add to the specified level if necessary.·Check if there is any leakage in the hydraulic brake system. | 32~33 |

| Item | Check | Page |
|--------------------------------------|---|-------|
| Throttle grip | <ul style="list-style-type: none"> ·Check for smooth operation. ·Check the grip free play. Contact Linhai dealer for adjustment and lubrication if necessary. | 34 |
| Bowdens / Cables | <ul style="list-style-type: none"> ·Check for smooth operation. ·Lubricate if necessary. | 33 |
| Wheels/Tires | <ul style="list-style-type: none"> ·Check for damage. ·Check tire pressure, wear and tread depth, adjust pressure or change tire if necessary. | 30~31 |
| Brake levers | <ul style="list-style-type: none"> ·Check for smooth operation. ·Lubricate the brake lever pivot if necessary. | 32 |
| Center stand and side stand | <ul style="list-style-type: none"> ·Check for smooth operation. ·Lubricate the pivots if necessary. | 34 |
| Fitting/fasteners | <ul style="list-style-type: none"> ·Check for loose fasteners. ·Tighten/adjust if necessary. | / |
| Meters, lights, signals and switches | <ul style="list-style-type: none"> ·Check for proper operation. Repair if necessary. | 9~13 |

BASIC OPERATION AND RIDING

Read the manual carefully and become familiar with all the functions. If you are unfamiliar with, or do not understand any operation or function, consult your local Linhai dealer.

⚠ WARNING

If you are unfamiliar with how your scooter works and handles, it may lead to an accident, injury or death.

Starting the engine

⚠ NOTICE

Before the first ride with your scooter, see page 39 for engine break-in information.

1. Turn the ignition switch on and make sure the engine stop switch is at RUN position.
2. Keep the throttle completely closed.
3. Squeeze the front or rear brake lever and press the start button to start the engine.
4. If engine fails to start, release the start button, wait for few seconds, and try again. Press the start button as briefly as possible to preserve the battery. Do not start the engine for more than 5 seconds in one attempt.

⚠ NOTICE

For longer engine life never accelerate hard before engine warms up. Always allow the engine to warm up before start riding.

⚠ NOTE

Warm up the engine before ride.

Starting control

1. Stand on the left side of the scooter and push it forward and off the center stand, or....
2. ...hold the scooter vertically and retract the side stand.
3. Mount the scooter from the left side, sit on the seat and adjust the rear view mirrors.
4. Before starting off, indicate your direction with the turn signals.
5. Pay attention to the traffic situation around you, hold the handlebars firmly with both hands and gradually open the throttle to start up.
6. Switch the turn signals off.

Accelerating and decelerating

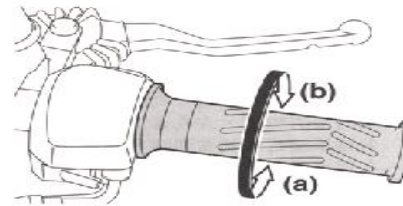

Speed can be controlled by turning the throttle grip. To accelerate, open the throttle in direction (a). To decelerate, close the throttle - direction (b).

Braking

⚠ WARNING

Avoid emergency or sudden braking (especially when in lean angle) to prevent the scooter from sliding, overturning and crash.

Road plates, covers, tramway rails, potholes, white markings on the roads, covers on building sites are slippery when wet. Always slow down and go across them carefully. Make sure the scooter is upright to avoid falling over.

Keep in mind that it is difficult to brake on wet surfaces. Slow down when driving on twisty roads, especially when going downhill where braking is more demanding.

1. Close the throttle.
2. To slow or stop, apply the front and rear brake simultaneously, gradually increase the braking force. Too much braking force may cause wheels to lock; using only one brake reduces stopping performance.
3. When braking in wet or rainy conditions or loose surfaces, the ability to maneuver and stop is reduced.
4. Before coming to a complete stop, put your left foot down first, then your right foot down.

Fuel-efficient driving tips

The way you ride determines whether your engine consumes too much fuel or not. Following tips can help you to ride your scooter with less fuel consumption:

- Ride smoothly. Avoid hard acceleration and heavy braking.
- Avoid high engine revs if there is no load.
- Consider stopping the engine instead of long idling (e.g. when long waiting on the traffic lights, or on railroad crossings etc.)

Engine break-in

There is never a more important period in the life of your scooter than the period between zero and **1000 km**. For this reason, read the following information carefully.

Since the engine is brand new, do not put an excessive load on it for the first **1000 km**. The various parts in the engine need a certain period of time to polish themselves to create the correct operating clearances. During this period, prolonged full throttle operation, or any condition which might result in engine overheating, must be avoided.

0~150 km

Avoid prolonged operation above 1/3 throttle. Stop the engine and let it cool down for 5 to 10 minutes after very hour of operation. Vary the

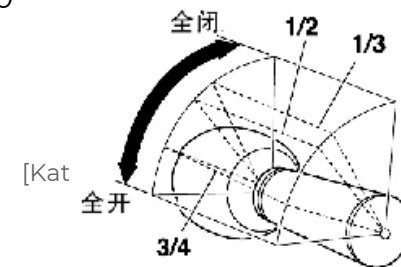

engine speed from time to time, don't run the engine in a fixed throttle position.

150~500 km

Avoid prolonged operation above 1/2 throttle. Do not use full throttle.

⚠ NOTICE

After first **500 km** of operation, change the final drive oil and then change it regularly according to the maintenance chart.

⚠ NOTICE

500~1000 km

Avoid prolonged operation above 3/4 throttle.

1000 km and beyond

Avoid prolonged full throttle operation, change the engine rpm occasionally.

⚠ NOTICE

If any engine trouble should occur during the break-in period, have a Linhai dealer check the scooter immediately.

Fully closed

Fully open

Parking

When parking the scooter, stop the engine and remove the ignition key.

⚠ WARNING

Because of the heat of a muffler and exhaust pipe, park the scooter at the places where the pedestrians and children are not likely to touch it.

Do not park the scooter on a slope as the scooter may turn over.

Do not park the scooter close to flammable materials such as dry grass or leaves to avoid risk of a fire.

⚠ WARNING

Because of the heat of a muffler and exhaust pipe, park the scooter at the places where the pedestrians and children are not likely to touch it.

Do not park the scooter on a slope as the scooter may turn over.

Do not park the scooter close to flammable materials such as dry grass or leaves to avoid risk of a fire.

⚠ WARNING

Because of the heat of a muffler and exhaust pipe, park the scooter at the places where the pedestrians and children are not likely to touch it.

Do not park the scooter on a slope as the scooter may turn over.

Do not park the scooter close to flammable materials such as dry grass or leaves to avoid risk of a fire.

⚠ WARNING

Because of the heat of a muffler and exhaust pipe, park the scooter at the places where the pedestrians and children are not likely to touch it.

Do not park the scooter on a slope as the scooter may turn over.

Do not park the scooter close to flammable materials such as dry grass or leaves to avoid risk of a fire.

Look for a level parking area. If you can't park on a paved surface, make sure the ground surface is firm.

Use the side or center stand to support the scooter while parked.

If you have to park on a soft surface, insert something solid under the stand for support.

Use the steering lock, which locks the handlebar in place.

Turn the handlebar all the way to the left or right. Push in on the ignition key and turn it to LOCK. Remove the key.

Park your scooter in a locked garage whenever possible. If a garage isn't available, park in a concealed area or in a well-lit area with enough pedestrian traffic to discourage thieves.

PERIODIC MAINTENANCE AND MINOR REPAIRS

Careful periodic maintenance will help keep your scooter in the safest, most reliable condition. The owner is responsible for performing the scheduled maintenance specified in this manual.

Inspect, clean, lubricate, adjust and replace parts as explained on the following pages and at the intervals specified in the periodic maintenance chart. We recommend that you have your Linhai dealer perform these services unless you have advanced mechanical skills and the required tools and equipment.

The service intervals in the maintenance chart are based on average riding. However, depending on weather, terrain, geographical locations, individual usage and other conditions, some items may need more frequent service and

⚠ WARNING

After the ride, engine, muffler and brakes may be hot. To avoid severe burns, do not touch hot parts until they cool down.



maintenance intervals may be shortened.

When inspections reveal the need for replacement parts, genuine Linhai parts are available from your Linhai dealer.

⚠ WARNING

Unless some maintenance procedures instruct otherwise, always stop the engine before maintaining the scooter to avoid injury. Your body or clothes may come into contact with running engine which may get you injured. Electrical system service may lead to electric shock or a fire. If you maintain or repair the vehicle while the engine is running, it may injure your eyes, cause a fire or lead to death due to carbon monoxide poisoning.

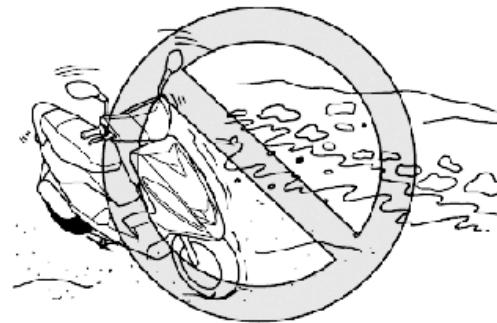

Emission control system in your scooter reduces the levels of harmful pollutants in the exhaust gases. Maintain the system according to the maintenance chart so as the exhaust gases meet the requirements.

⚠ NOTICE

Do not disassemble or service any part of the emission control system or it may reduce engine performance and increase levels of harmful substances in the exhaust gases. This service should be performed by your dealer.

Tool kit

Tool kit is stored in the storage compartment under the seat. Service information in this manual and supplied tool kit can provide you with all the necessary supplies to complete most of periodic maintenance jobs and minor repairs. However, other tools such as torque wrench are sometimes necessary to perform the maintenance correctly.

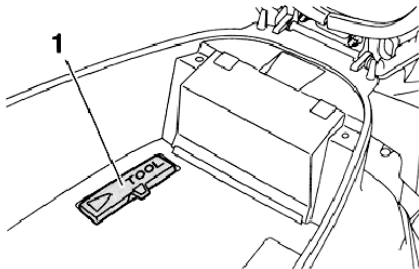

⚠ NOTE

If you do not have tools or skills necessary to complete a procedure properly, take your vehicle to Linhai dealer for service.

Spark plug inspection

Spark plug is a vital engine part that is easy to inspect. Heat and carbon accumulation can gradually erode the spark plug electrodes. Spark plug should be inspected regularly in intervals specified in the maintenance chart. Spark plug condition is indicative of engine condition.

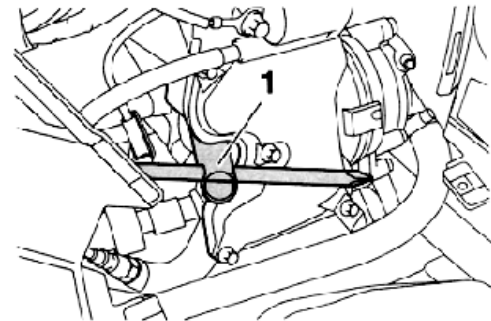

Spark plug removal

1. Place the scooter on its center stand.
2. Remove the front cover.
3. Disconnect the spark plug cap.
4. Using the spark plug wrench from the tool kit remove the spark plug (counterclockwise).

Spark plug inspection

1. Check if the color of the white porcelain insulator around the center electrode. A light brown insulator indicates that the plug is correct. A white or dark insulator indicates that the engine may need to be serviced.
2. Check if the electrodes aren't eroded or excessively fouled with carbon. Change the spark plug if necessary.
3. Measure the electrode gap with a spark plug gauge and adjust the gap if necessary.

⚠ NOTE

If the color of the spark plug is totally different, it may be caused by the abnormal operation of an engine. Do not attempt to diagnose problems by yourself. Instead, take the scooter to your authorized Linhai dealer for inspection.

| | |
|-------------|--------|
| Spark plug: | CPR8EA |
|-------------|--------|

| | |
|-----------------|------------|
| Spark plug gap: | 0.7-0.8 mm |
|-----------------|------------|

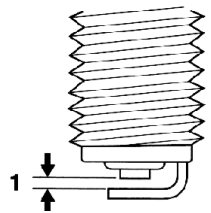

1. Spark plug gap: 0.7-0.8 mm

Spark plug installation:

1. Clean the spark plug gasket and wipe off any dirt from spark plug thread.
2. Install the spark plug with the spark plug wrench clockwise and tighten to specifications.

| |
|-------------------------------------|
| Tightening torque Spark plug: 12 Nm |
|-------------------------------------|

3. Reinstall the spark plug cap.

⚠ NOTE

If you do not have a torque wrench for installing the spark plug, screw the spark plug tightly by your hand and then tighten it by 1/4~1/2 turns further with a supplied wrench.

Engine oil and oil strainer

Before every ride always check the engine oil level and whether there are any leaks. If you find any leakage, take your scooter to your Linhai dealer for inspection.

⚠ NOTE

The oil level should be between the maximum and minimum marks.

Engine oil should be regularly replaced and the oil strainer regularly cleaned in intervals specified in the maintenance chart. When operating in very dusty conditions, oil should be changed more frequently than specified in the maintenance chart.

Engine oil level inspection

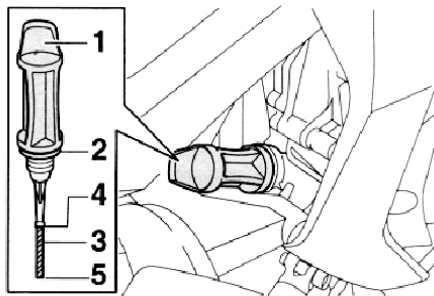

1. Oil filler cap
2. O-ring
3. Oil dipstick
4. Upper level
5. Minimum level

1. Place scooter on its center stand on a firm, level surface. Slanted scooter may cause misreading.
2. Start the engine, warm it up for a several minutes and stop the engine.
3. Wait for a few minutes to let the oil settle down and remove the oil filler cap (counterclockwise). Wipe the dipstick clean, insert it back until it seats, but don't screw it in. Remove the dipstick and check the oil level.
4. If the oil is below or near the lower level mark, add the recommended oil until it reaches the upper level mark. (Do not overfill).
5. Reinstall the oil dipstick, tighten it securely clockwise and check for oil leaks.

Engine oil change

Have the engine oil changed by your Linhai dealer in intervals specified in the Maintenance chart, or sooner when running in very dusty conditions. While changing the oil, service will also clean the oil strainer.

Recommended engine oil: **Maxima Scooter 10W40**

Final Drive oil

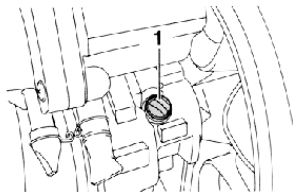

1. Final drive oil

Before every ride check, if there is any leakage in the final drive. If you find any leakage, take your scooter to your Linhai dealer for inspection. Final drive oil should be regularly replaced in intervals specified in the maintenance chart.

Final drive oil change

Have the final drive oil changed by your Linhai dealer in intervals specified in the Maintenance chart.

Recommended final drive oil: **Maxima Gear Oil**

Coolant

The cooling system has two main parts: radiator and reservoir. Check the coolant level in reservoir before every ride. Since the coolant level changes with engine temperature, level should be always checked when the engine is cold. In addition, change the coolant regularly in intervals specified in the maintenance chart.

Coolant level inspection

Before every ride check that the coolant in reservoir.

1. Place the scooter on its center stand, on a level surface.

⚠ NOTE

*Since the amount of coolant changes with the engine temperature, it must be checked after the engine has cooled down.

2. Inspect the coolant level.

⚠ NOTE

Coolant level should be between "F" and "L" marks.

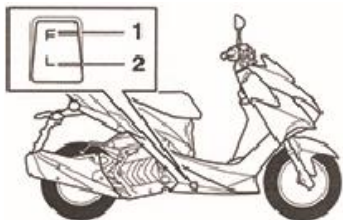

1. Maximum Level „F“ (Full)
2. Minimum Level „L“ (Low)

3. If coolant level is below the "L" mark, remove the reservoir cap (under the floorboard cover) and add coolant as required to bring the coolant level to the FULL level mark.

⚠ WARNING

Do not remove the radiator cap when the engine and radiator are hot. Removing the radiator cap while the engine is hot can cause the coolant to spray out, seriously scalding you. Always let the engine and radiator cool down before removing the radiator cap.

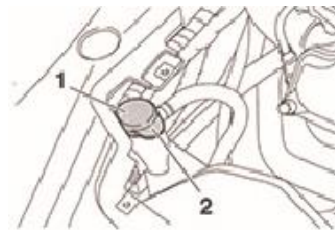

1. Reservoir cap
2. Reservoir cap flap

4. Add coolant to the reservoir as required to bring the coolant level to the FULL mark. Then install the reservoir cap and floorboard cover.

⚠ NOTE

When installing the coolant reservoir cap, the flap of the fill plug must aim to the left. Otherwise it could get trapped by the floorboard cover.

⚠ WARNING

Never add hard or salt water as it is harmful to the engine. Use only distilled water. Softened tap water may be used too, if distilled water is not available. If you have used soft water, contact authorized Linhai service.

Recommended coolant: Glycol-based coolant
Reservoir tank capacity: 0,25 L

Coolant replacement

Coolant must be replaced regularly. Have the coolant replaced by your Linhai dealer in intervals specified in the maintenance chart.

Main air filter and V-belt air filter

Main air filter element and V-belt air filter element should be replaced (main air filter element) / cleaned (V-belt air filter element) regularly according to the maintenance chart. Air filters should be changed / cleaned more frequently if you ride often in wet or dusty environments.

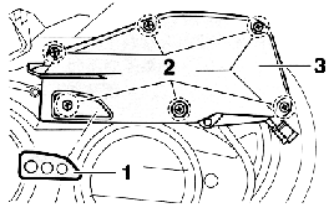

1. Plug
2. Screws (×6)
3. Air filter cover

1. Main Air filter element

Main Air Filter Element Change

1. Place the scooter on its center stand.
2. Remove the screws and main air filter cover.
3. Remove the main air filter element.
4. Check the condition of the main air filter element. If the filter is too dirty or damaged, replace it with a new one. Main filter is dry-type paper filter and cannot be cleaned.

5. Install a new air cleaner element.
6. Install the air filter cover and tighten the screws.

⚠ NOTICE

Make sure that the air filter element is installed in the air box correctly.

Do not operate the engine without an air filter element in place, or this can cause damage to internal engine parts, such as valves, piston and cylinder walls.

Clean Air Filter Box Sediment Tube

1. Check if there is any water or oil in the sediment tube.
2. If there is too much water or oil in the tube, remove it, drain the deposits and reinstall the sediment tube.

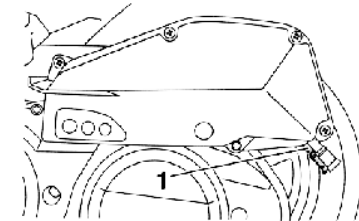

Clean V-belt Air Filter Element

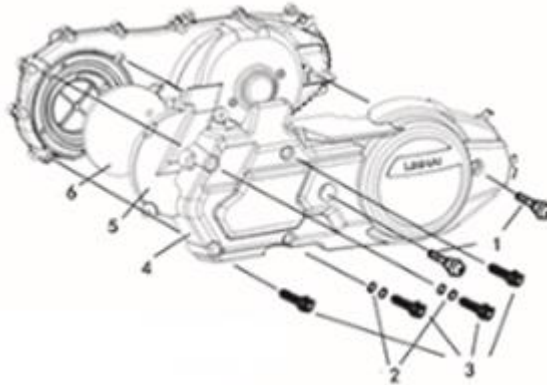

- ① Screw 2x
- ② Washer 2x
- ③ Bolt 4x
- ④ Outer cover
- ⑤ Filter cover
- ⑥ V-belt air filter element

To maintain the optimum life and correct operation of the drive system, V-belt air filter must be cleaned whenever is dirty or stained.

1. Remove 2 screws ①.
2. Remove 4 washers ② and 4 bolts ③.
3. Remove outer cover ④ and filter cover ⑤.
4. Remove the filter, clean it with a suitable solvent and squeeze the filter to remove excess solvent. Dry the filter element.

⚠ WARNING

To clean the V-belt air filter element, use only the specialized parts cleaning solvent. To avoid a risk of fire or an explosion, do not use gasoline or flammable solvents.

⚠ NOTICE

Be careful when cleaning V-belt air filter. Torn air filter can cause damage to the drive system.

5. Oil the V-belt air filter element with recommended oil. Squeeze out the excess oil.

⚠ NOTE

Keep the V-belt air filter element damp, but oil should not be dripping from it.
If the air filter element is too dirty or torn, replace it with a new one.

Recommended V-belt air filter oil: Engine oil

6. Install V-belt air filter element aligning the positioning holes of the air filter on the positioning pins.
7. Install V-belt air filter cover, outer cover, all washers, bolts and screws in reverse order.

When installing, align the positioning holes of the air filter element on the positioning pins with the yellow side of the filter facing outward.

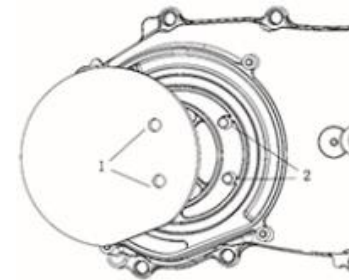

- 1. Positioning holes (2x)
- 2. Positioning pins (2x)

Throttle Grip Free Play Inspection

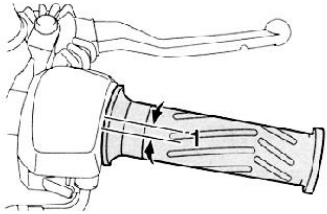

1. Free play
The throttle cable free play at the lip of the throttle grip should be 3~5 mm. If adjustment is needed, have it adjust by a Linhai dealer.

Valve Clearance Adjustment

The valve clearance will change with the use of vehicle, resulting in improper fuel/air supply and engine noise. To prevent this, the valve clearance must be adjusted regularly according to the maintenance chart. This adjustment should be performed by a professional service technician. Contact your Linhai dealer for service.

Tires

To ensure maximum performance, long life and safe operation, check tire pressure regularly.

Tire pressure

Always check and adjust the tire pressure before operating the scooter.

⚠ WARNING

•Always maintain proper tire pressure. Operating the scooter with improper tires, or with improper or uneven tire pressure could cause loss of control and severe injury or death. Always use size and type of tires specified for your vehicle.

- Never overload the scooter. Overloading can cause loss of control and accident.
- Check and adjust tire pressure only when tires are cold (tires have ambient temperature)

⚠ WARNING

Cold tire pressure:

| | |
|----------------------|----------------|
| 1 person (0~90kg) | Front: 171 kPa |
| | Rear: 196 kPa |
| 2 persons (90~150kg) | Front: 196 kPa |
| | Rear: 220 kPa |
| Total load limit: | 150 kg |

Tread Wear

Inspect the tires before each ride. Inspect the tread depth and replace the tires when the center tread depth reaches 1,6 mm. If the tire has a cut or puncture, or if the sidewall is cracked, have the tire replaced by an official Linhai dealer as soon as possible.

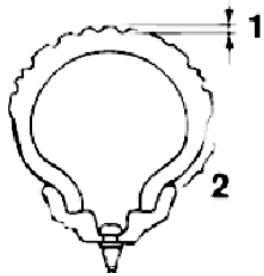

Minimum tire tread depth
(front and rear tire): 1,6 mm

1. Tread depth
2. Tire sidewall

Tires

Use only tubeless tires on your scooter. After extensive tests, only the following tires have been approved by Linhai for this scooter.

Front tire: 110/80-14 M/C 53P

Rear tire: 130/70-13 M/C 63P

After changing a tire, ride conservatively to allow the tire to seat itself on the rim properly.

⚠ WARNING

Change the worn tire as soon as possible.

Driving with worn tires will impair driving stability and can lead to loss of control.

Have the tires, or wheel or brake components changed at a Linhai dealer, as they have the necessary knowledge and experience.

Wheels

To ensure maximum performance, long service life and safe operation, pay attention to the following points:

Inspect the wheels for cracks, bends, damage or warpage before every ride. If you find any damage, have the wheel replaced by a Linhai dealer. Do not attempt to repair the wheels yourself. Deformed or cracked wheels must be replaced.

Front/Rear Brake Inspection

There should be no free play at the end of brake lever. If there is free play, ask Linhai dealer to check the brake system.

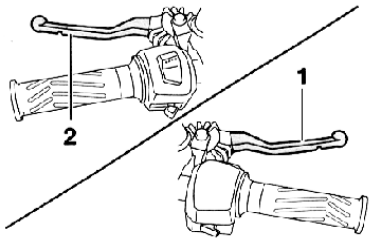

1. Front brake lever
2. Rear brake lever

⚠ WARNING

If proper adjustment cannot be obtained, ask a Linhai dealer for adjustment.

⚠ WARNING

If the brake lever feels loose and spongy, it may indicate air in the brake system. Have a Linhai dealer bleed the system before operating the scooter. Air in the brake system can reduce the braking performance which may result in loss of control and an accident.

Front /Rear Brake Pad Inspection

Follow the maintenance chart and check the front and rear brake pads regularly for wear.

Front brake

Rear brake

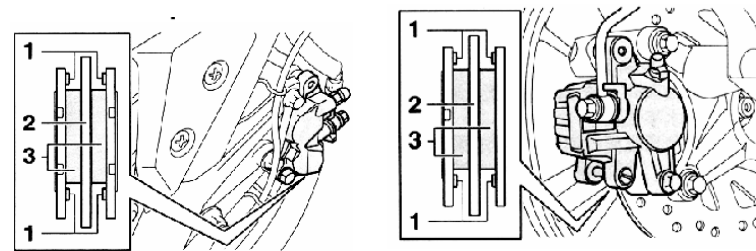

1. Brake pad wear indicator (front/rear)
2. Brake disc (front/rear)
3. Brake pads (front/rear)

Every brake pad is equipped with wear indicator to allow you check the brake pad wear without disassembling the brake. Check the wear indicators to find out how much the brake pads are worn. If the indicator groove almost disappeared, have the brake pads replaced by your Linhai dealer.

Brake Fluid Inspection

If the brake fluid level is insufficient, air may enter the brake system, which may result in insufficient braking performance. Before the ride check if the brake fluid is above the minimum level. If the brake fluid level is low, check the brake pads for wear and brake system for leakage.

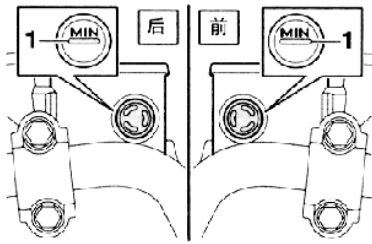

1. Minimum level

Brake Fluid Maintenance:

- When inspecting the brake fluid level, make sure the top of the brake fluid reservoir on the handlebars is horizontally.
- Use only DOT 3 brake fluid. Other brake fluids may deteriorate rubber seals, cause brake fluid leakage or poor brake performance.

Recommended brake fluid: Maxima DOT3 Brake fluid

⚠ NOTE

If DOT 3 is not available, DOT 4 brake fluid can be used.

• Refill with the same type of brake fluid. Mixing different brake fluids can lead to unwanted chemical reaction and reduce brake performance.

• Be careful that water does not enter the brake fluid reservoir when refilling. Water significantly lowers the boiling point of the brake fluid and may result in vapor lock.

• Brake fluid may damage painted and plastic surfaces.

Always clean up all spilled brake fluid immediately.

• It's normal that the brake fluid level goes down gradually as the brake pads wear. Anyway, if the brake fluid level descends rapidly, take your scooter to official Linhai dealer for inspection.

Brake Fluid Replacement

Have a Linhai dealer replace the brake fluid, master cylinder seals, caliper seals and brake hoses regularly in intervals specified in the maintenance chart, or when they are damaged or leak.

Brake fluid: Replace every year or every 12 000 km.

Brake fluid seals: Replace every 2 years.

Brake hoses: Replace every 4 years.

Cables Inspection and Lubrication

Inspect operation and condition of control cables before every ride. Lubricate the inner cable and both cable ends if necessary. If a cable does not operate smoothly, have it replaced by your Linhai dealer.

⚠ WARNING

Damage to the cables outer protective housing may result in cable internal rusting and cause interference with cable movement. Replace damaged cable as soon as possible to prevent unsafe conditions.

Recommended control cables lubricant:

Suitable lubricant for chains and cables, or engine oil.

Throttle grip and cable inspection and lubrication

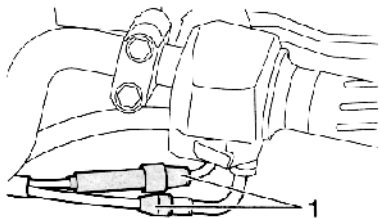

1. Throttle cable dust covers

Before each ride always inspect the throttle grip for smooth operation. Also, check if throttle cables are in good condition and are working properly. In addition, have your Linhai dealer lubricated throttle grip and cables regularly in intervals specified in the maintenance table. Throttle cable is equipped with rubber dust covers; make sure the cover is

installed correctly. Anyway, even when the rubber cover is installed correctly, it cannot fully prevent the moisture from entering the cable. Therefore do not direct water onto the rubber cable covers and cables when washing your scooter. If rubber covers or cables become dirty, use a damp cloth to wipe them.

Front and Rear Brake Lever Lubrication

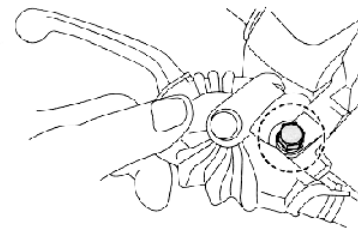

Follow the maintenance chart in this manual and lubricate front and rear brake lever pivot bolts regularly.

Recommended lubricant:

Special lubricant for chains and cables, or engine oil.

Center and Side Stand Inspection and Lubrication

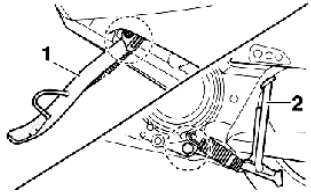

1. Side stand
2. Center stand

Check if the center and side stands are working properly before every ride. If necessary, lubricate the pivot bolts as well as contact metal surfaces.

If the center or side stand does not move smoothly, or if any of the springs lost tension and cannot fully retract the center stand or side stand, have the stands checked by authorized Linhai dealer. An improperly retracted side stand or center stand could contact the ground and cause a loss of control resulting in serious injury or death.

⚠ NOTICE

Recommended grease: Lithium soap based grease

Front fork inspection

Check condition and function of the front fork regularly.

What to check

Check the inner tubes for scratches, damage and excessive oil leakage.

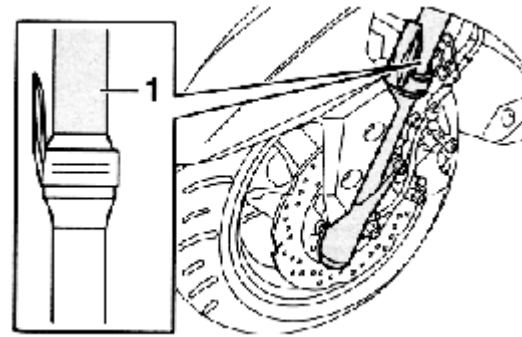

1. Front fork inner tube

⚠ WARNING

Securely support the scooter so there is no danger of it falling over.

How to check

1. Place the scooter on a flat place and hold it upright.
2. While holding the handlebars and applying the front brake, pump the forks up and down several times. Check for smooth compression and returning of the front fork. Front suspension should operate smoothly and quietly.

⚠ NOTICE

If there is any damage on front fork, or the fork operation is not smooth, have the front fork checked or replaced by authorized Linhai dealer.

Steering inspection

Worn out or loose steering bearings may be dangerous. Always inspect the condition of the steering as described. A lack of grease in the bearings of the steering column can cause dangerous situations. For your safety, have your Linhai dealer check and repack the steering column bearings every 10 000 km. Check the operation of the steering regularly according to the maintenance chart.

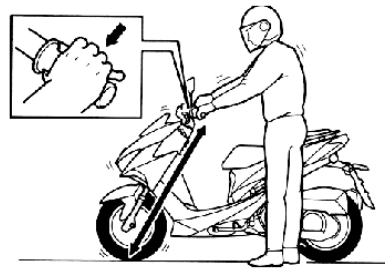

1. Place the scooter on its center stand.

⚠ WARNING

Securely support the scooter so there is no danger of falling it over.

2. Hold the lower ends of the front forks and raise the front wheel off the ground. Try to move front fork forward and backward. If any free play can be felt, have the front fork inspected and serviced by authorized Linhai dealer.

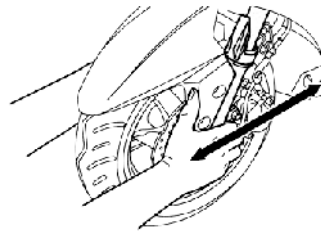

Wheel bearing inspection

Wheel bearings should be inspected according to the maintenance chart. Check for looseness or damage. If the front or rear wheel bearings have free play in the wheel hub or if the wheel does not turn smoothly, have it inspected by your Linhai dealer.

Battery

The battery is located in the underseat compartment. To access the battery, remove the battery cover.

Your scooter is equipped with sealed MF battery that requires no maintenance. Never add electrolyte or distilled water to this battery. However, it is necessary to regularly clean battery terminals and check that cables are firmly attached to the terminals and tighten them if necessary. For cleaning battery terminals use Maxima Electrical Contact / Brake Cleaner.

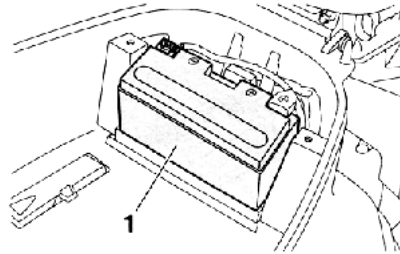

⚠ NOTICE

- Never attempt to remove the battery sealing caps or you will irreparably damage the battery.
- When the voltage drops under 12 V, or when the battery is completely flat, the engine cannot be started.
- If you notice that the starter motor cranks the engine slowly, have your Linhai dealer check the condition of the battery and charging system.

⚠ WARNING

12V batteries contain toxic and corrosive sulfuric acid and may produce flammable and explosive hydrogen gas. Even maintenance-free batteries contain electrolyte in gel form. To reduce the risk of serious injury or death, the following precautions should be observed when handling 12V batteries, or working near them:

Keep sparks, flame, cigarettes, etc. away.

Be sure to charge the battery in an open area. Do not charge a 12V battery in a poorly ventilated garage or closed room.

Do not smoke or light a match near a 12V battery.

Avoid splashing electrolyte on eyes, skin and clothes.

Wear safety goggles when working near 12V battery.

KEEP 12V BATTERIES OUT OF REACH OF CHILDREN.

Antidote:

- **External:** Flush with water.
- **Internal:** Drink large quantities of water or milk. Call doctor immediately.
- **Eyes:** Flush with water for 15 minutes and get prompt medical attention.

Battery Charging

Batteries require regular cleaning and recharging in order to deliver peak performance and maximum service life. If your scooter is equipped with optional electric accessories, the battery can discharge faster.

Improper charging may damage the battery. Using a charger that is not designed to charge maintenance-free batteries may destroy or irreparably damage your battery. We recommend using a Shark CN-4000 Smart Automatic Charger to charge your battery. This charger can be left connected for long periods without risking damage to the battery.

Battery Storage

1. Whenever the scooter is not used for a month or more, remove the battery from the scooter, ensure that it's fully charged, and store it in a cool, dry place. Check battery voltage every month during storage and recharge as needed to maintain a full charge.

⚠ NOTICE

When removing the battery, turn the main switch to "OFF", then disconnect the negative (–) cable first and then disconnect the positive (+) cable. Improper connecting or disconnecting battery cables can result in an explosion and cause serious injury or death. Always disconnect the negative (–) cable first.

2. If the scooter is going to be stored for more than two months, recharge the battery to full capacity every 30 - 60 days.
3. Always fully charge the battery before installing it into the vehicle.
4. When reinstalling the battery, always connect the positive (+) cable first, negative (black) cable last.
5. Make sure the connections are tight and do not forget to install the rubber boot on positive battery terminal.

⚠ NOTICE

Make sure the battery is fully charged. Storing discharged battery will degrade the battery.

Fuse

If the engine stops or won't start, or if you experience other electrical failure, a fuse may need replacement. Before checking or replacing the fuse, locate and correct any short circuits that may have caused the blown fuse, then replace the fuse. Spare fuses are provided in the fuse box located under the seat, next to the battery. To access the fuse box, remove battery cover.



1. Fuse box

⚠ WARNING

Always replace a blown fuse with the fuse of the same type and rating. Do not replace the fuse with anything else. Using an improper fuse can cause damage to the electrical system and may lead to a fire.

Fuse: 20A/30A (ABS)

Fuse replacement

1. Turn the ignition switch off.
2. Remove the burnt fuse and install a new fuse of the same type and rating.
3. Turn on the ignition switch and check if electrical circuits are working normally.
4. If the new fuse immediately blows again, contact authorized Linhai dealer.

OBD connector

The OBD connector is next to the battery. Remove the battery cover to access the OBD connector.



LED Headlight Lamp Replacement

The LED Headlights are not serviceable. If the headlight becomes damaged or inoperable, the entire assembly must be replaced. Contact your authorized Linhai dealer.

LED Turn signals/Tail/Brake/Position light replacement

The LED Turn Signals / Tail / Brake / Position lights are not serviceable. If any of the lights become damaged or inoperable, the entire assembly must be replaced. Contact your authorized Linhai dealer.

Rear view mirrors

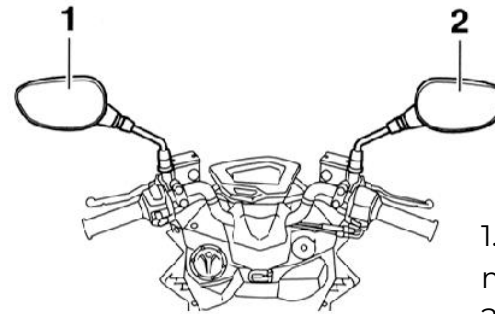

1. Left rear view mirror
2. Right rear view mirror

Troubleshooting

Although all Linhai vehicles are thoroughly inspected in the factory, there can occur problems later during use. The following troubleshooting chart can help you check the main systems swiftly and easily. Anyway, if your scooter requires any repair, take it to a Linhai dealer. Our professional and skilled technicians have special tools, experience and knowledge to service your scooter properly. Use only original Linhai spare parts for maintenance and replacement. Aftermarket parts may look like original Linhai parts, but they are often poor quality products and their service life is shorter and can lead to extra maintenance costs.

⚠ WARNING

Never check the fuel system while smoking or in the vicinity of an open flame, such as gas water heater, furnace or stove etc. The fuel or the gas may be ignited and can explode, and it could cause severe accident.

Troubleshooting chart

1. Fuel

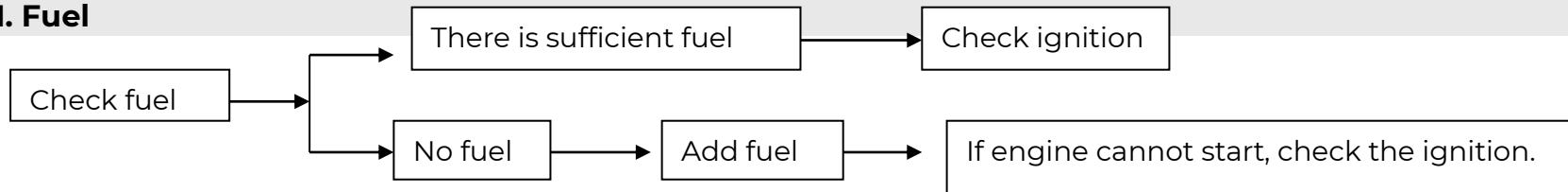

2. Compression

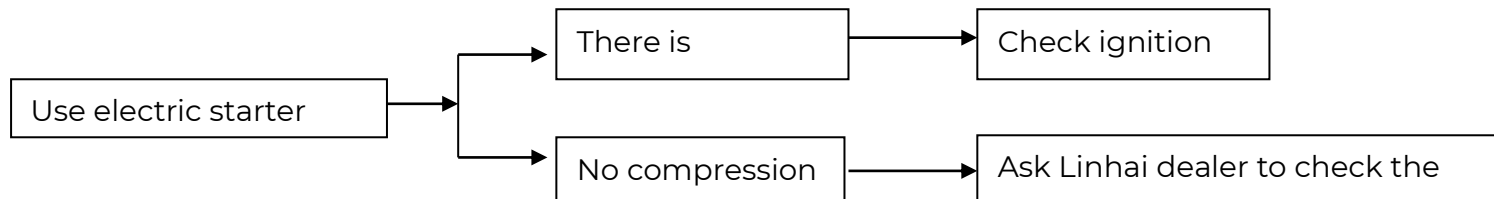

3. Ignition

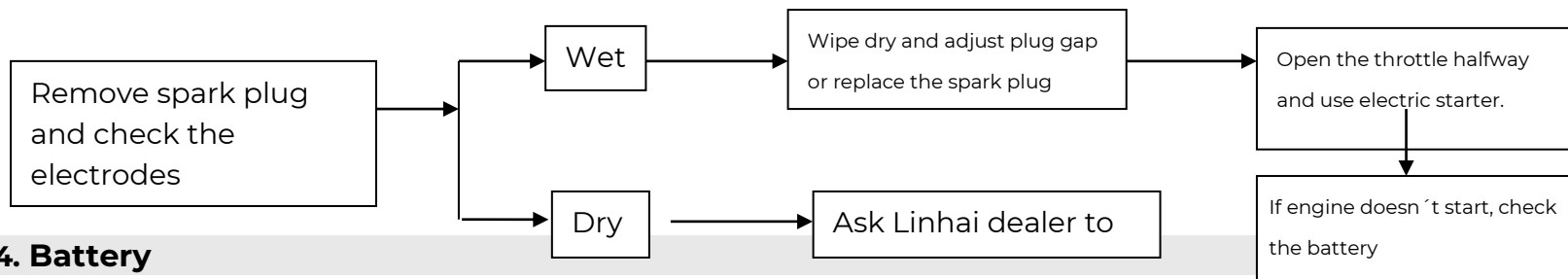

4. Battery

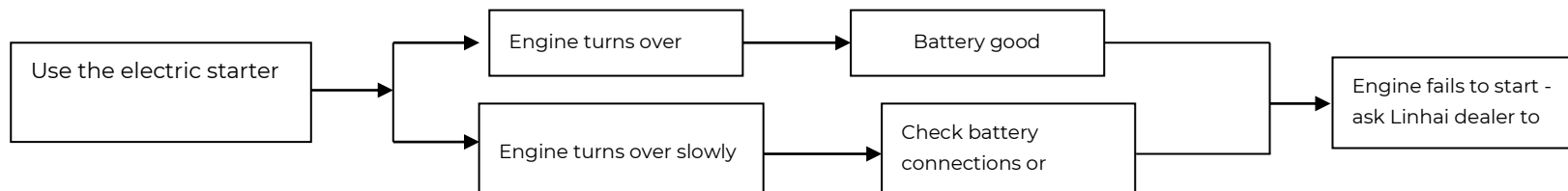

CLEANING AND STORAGE

Cleaning

Keeping your scooter clean not only improves its appearance, but can also extend the life of the components. Proper care will let your scooter look like new, but also extend its life and optimize its performance.

Washing the scooter:

1. Engine and exhaust must be cold before washing.
2. After the engine has cooled down, cover the exhaust with a plastic bag and make sure that all filler caps, covers and electrical couplers and terminals (including the spark plug cap) are tightly on place.
3. Clean your scooter with a garden hose, soft cloth or sponge, and mild neutral soap.
4. Remove extremely stubborn grease with a degreaser and brush. Do not apply degreaser onto oil seals, gaskets or wheel axles.
5. Rinse the dirt and degreaser off with water.

⚠ NOTICE

·Improper cleaning can cause damage to windscreens, cowlings and other plastic parts. Use only a clean soft cloth or sponge, soft water and mild soap to clean plastic parts.

·Never use abrasive cleaning products or harsh chemicals such as solvents, gasoline, products containing ammonium, thinners etc.

·Never use harsh chemical products on plastic parts. Avoid using clothes or sponges that are stained with strong or abrasive detergents, gasoline, dust, grim, sand, brake fluid, antifreeze, electrolyte etc.

·Never use high pressure car washers as they can cause damage to the sealed parts such as tires, wheel bearings, front forks, brakes, electrical components such as connectors, terminals, LCD displays, switches, lights, breather hoses, graphic stickers, air intakes and vents.

·For the vehicles equipped with windscreen: do not use strong detergents or hard sponge since they will scratch the windscreen and blur it. If you are not sure whether given product will scratch your windscreen or not, you may test it on some inconspicuous area of the windscreen.

Cleaning after normal riding

Use warm water, neutral detergent and soft clean sponge to remove the dirt, and then rinse thoroughly with clean water. Use toothbrush or bottle brush to clean the difficult to reach places. For a better cleaning effect, you can cover places with the stubborn dirt and dried insects with a wet cloth for few minutes before cleaning so the dirt comes off more easily.

Cleaning after riding in rain, winter or near the sea

Due to the excessively corrosive nature of salt, always carry out the following steps:

1. Clean the scooter with cold water and mild detergent, after the engine has cooled down.

⚠ NOTICE

Never use warm water as it increases the corrosive action of the road salt.

2. Apply a corrosion protection spray on all metal surfaces to prevent rusting.

After cleaning

1. Dry all surfaces with a chamois, clean towel, or soft cloth.
2. Apply a coat of anti-rust spray on all metal parts including exhaust pipe and chrome- and nickel-plated surfaces to prevent corrosion.
3. Use spray oil as a universal cleaner to remove any remaining dirt.
4. Touch up minor paint scratches caused by stones hitting the scooter etc.
5. Apply car or motorcycle wax to all painted surfaces.
6. Let the scooter dry completely before storing or covering it.

⚠ WARNING

Contaminants on the brakes or tires can cause loss of control and accident.

Make sure there is no oil, grease or wax on the brakes and tires. If cleaning is needed, use specialized brake parts cleaner to clean brake discs and brake pads.

Wash tires with warm water and neutral detergent.

Always test the brakes after washing.

⚠ NOTICE

•Apply spray oil and wax sparingly and make sure to wipe off any excess.

•Never apply oil or wax to any rubber and plastic parts, but treat them with a suitable dedicated care products.

•Avoid using abrasive polishing compounds as they will wear away the paint and damage painted surfaces.

⚠ NOTE

•Consult a Linhai dealer for advice on what products may be used.

•After washing or riding in rainy days or foggy weather, the headlights may mist up temporarily. Turning the headlights on for some time may reduce the condensation and mist.

Storage

Short-term storage

Be sure the storage area is dry and cool. Cover the scooter with a breathable dustproof cover if needed.

⚠ NOTICE

- Storing wet scooter in a poorly ventilated room, or covering it with dustproof cover while it is still wet, will start or speed up corrosion process.
- To avoid corrosion, never store your scooter in a damp cellar, an animal house (due to the presence of ammonia) or in places where strong chemicals are stored.

Long-term storage

Before storing your scooter for several months:

1. Follow all the instructions in the MAINTENANCE section.
2. Fill up the fuel tank and add fuel stabilizer (if available) to prevent the fuel tank from rusting and the fuel from deteriorating.
3. Perform the following steps to protect the cylinder, piston rings, etc. from corrosion:
 - Remove the spark plug cap and spark plug.
 - Pour engine oil of about 6 ml in the spark plug hole.
 - Reinstall the spark plug cap on the spark plug and place the plug on the cylinder head to ground the electrode to prevent the spark plug sparking in the next step).

- Crank the engine several times to coat the cylinder walls with oil.
- Reinstall the spark plug and spark plug cap.

⚠ WARNING

- Always make sure the spark plug electrode is grounded before starting the engine to avoid damage or injury caused by the sparking.
4. Lubricate all control cables and pivoting parts of levers, center and side stand.
 5. Check the tire pressure and adjust it if necessary. Store the scooter on center stand, otherwise rotate the wheels a little once a month to avoid flat spots.
 6. Tie a plastic bag over the exhaust pipe to prevent moisture from entering it.
 7. Remove the battery and recharge it once a month. Do not store the battery in an excessively warm or cold place (less than 0°C or higher than 30°C). For more information about the battery storage refer to page 58.

⚠ NOTE

Make any necessary repairs before storing the vehicle.

SPECIFICATIONS

| Dimensions and Weights | |
|--------------------------------------|---------------------|
| Overall length | 1980 mm |
| Overall width | 740 mm |
| Overall height | 1220 mm |
| Seat height | 800 mm |
| Wheelbase | 1390 mm |
| Ground clearance | 90 mm |
| Maximum turning radius | 2200 mm |
| Mass in running order ¹ | 147 kg |
| Passengers capacity | Rider + 1 passenger |
| Maximum weight capacity ² | 150 kg |
| Total weight | 297 kg |

¹ - With oil and full fuel tank

² - Including Rider, Passenger, Luggage and Accessories

| Engine | |
|----------------------|-------------------------------|
| Engine type | 4-stroke, SOHC, 4 valves |
| Cylinder arrangement | Single cylinder, water-cooled |
| Displacement | 125 ccm |
| Bore x Stroke | 52 x 52.6 mm |
| Compression ratio | 11 : 1 |
| Starting system | Electric starter |
| Lubrication system | Wet sump |

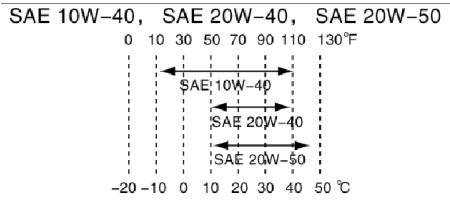
| Engine oil (4-stroke): | |
|--------------------------------|---|
| Recommended engine oil | SAE 10W-40, SAE 20W-40, SAE 20W-50  |
| Capacity - periodic oil change | 0,95 L |
| Final drive oil | |
| Recommended final drive oil | SAE 15W-40 |
| Capacity - periodic oil change | 0,2 L |

| Air filter | |
|---------------------------|---------------------------------|
| Air filter | Dry paper element |
| Fuel | |
| Type | Unleaded petrol, 95 octane, E10 |
| Fuel tank capacity | 12 L |
| Cooling system | |
| Reservoir tank capacity | 0,25 L |
| Spark plug | |
| Manufacturer/Type | NGK/CPR8EA |
| Transmission | |
| Primary reduction ratio | 1.000 |
| Secondary reduction ratio | 8.787 (45/13×33/13) |
| Final drive | Gear |
| Transmission type | V-belt (CVT) |
| Chassis | |
| Frame Type | Steel, Under bone |
| Caster angle | 27° |

| Tires | |
|-------------------------------|-----------------------------|
| Front | 110/80-14 M/C 53P, tubeless |
| Rear | 130/70-13 M/C 63P, tubeless |
| Tire pressure | |
| Driver only: | |
| Front tire | 171 kPa |
| Rear tire | 196 kPa |
| 2 persons (90-150 kg): | |
| Front tire | 196 kPa |
| Rear tire | 220 kPa |

| Front wheel | |
|-------------------------|------------------------------|
| Type | Aluminum rim |
| Size | |
| Rear wheel | |
| Type | Aluminum rim |
| Size | |
| Front brake | |
| Type | Disc brake |
| Operation | Right hand operation |
| Rear brake | |
| Type | Drum brake |
| Operation | Left hand operation |
| Brake fluid | |
| Recommended brake fluid | Maxima DOT 3 (Refer to p.33) |
| Front Suspension | |
| Type | Telescopic fork |
| Shock absorber | Coil spring and oil damper |
| Rear Suspension | |
| Type | Unit swing arm |
| Shock absorber | Coil spring and oil damper |

| Electric system | |
|--|--------------------|
| Ignition system | ECU |
| Charging system | Magneto |
| Battery | |
| Type | YTX7A-BS |
| Capacity | 12V 6Ah |
| Smart lock system battery current draw in standby mode | approximately 2 mA |
| Key Fob Battery: | CR2032 |
| Lights | |
| Headlights | LED |
| Tail Light / Brake light | LED |
| License plate light | LED |
| Rear turn signal | LED |
| License plate lamp | LED |
| Rear tail light/rear brake light | LED |
| Fuse | |
| Fuse | 20A/30A (ABS) |

Vehicle Identification

Record the Vehicle Identification Number and Engine serial number in the spaces provided for ordering spare parts from a dealer or for reference in case the vehicle is stolen.

Vehicle Identification Number:

Engine Serial Number:

Engine serial number

Engine serial number is stamped into the crankcase.

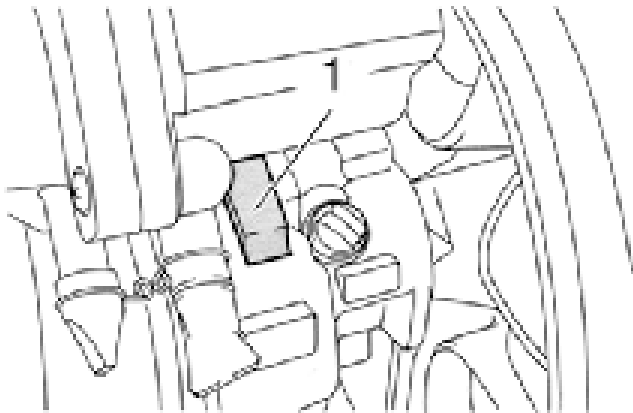

Vehicle Identification Number

Vehicle Identification Number is stamped on the frame as shown in the picture. Open the seat to see the Vehicle Identification Number.

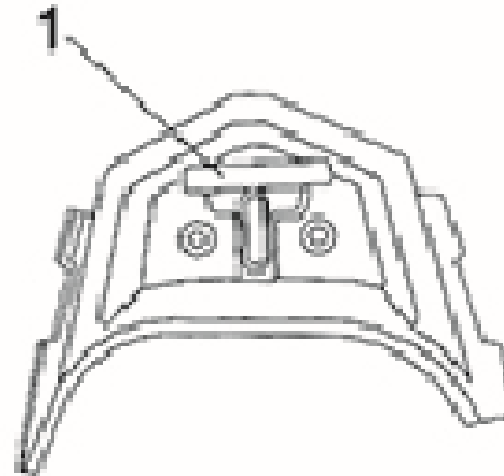

PERIODIC MAINTENANCE CHART

| Item | | Check | First 1 000 km or 1 month | First 3 000 km or 3 months | Every 3 000 km or 3 months |
|----------------------------------|---|---|------------------------------|-------------------------------|-------------------------------|
| Valves* | S | Check valve clearance. Adjust if necessary. | ○ | | ○ |
| Spark plug | | Check condition. Clean or replace if necessary. | | ○ | ○ |
| Air filter - engine | | Clean. Replace if necessary. | | ○ | ○ |
| Air filter - V-belt | | Clean. Replace if necessary. | | ○ | ○ |
| Fuel lines | | Check fuel hose for cracks or damage. Replace if necessary. | | | ○ |
| Engine oil | S | Replace. | First 500 km | Every 2 000 km | Every 2 000 km |
| Oil drain plug (side) * | S | Drain oil. | ○ | ○ | ○ |
| Engine oil strainer (bottom)* | S | Clean. Replace if necessary. | ○ | ○ | ○ |
| Final drive oil | S | Replace. | First 500 km | Every 2 000 km | Every 2 000 |
| Coolant | | Change. | | | 10 000 km or 12m |
| Drive Belt * | S | Check for damage/ wear. Replace if necessary. | | ○ | ○ |
| Brake system | | Check operation. Adjust if necessary. | | ○ | ○ |
| Brake system | | Check operation. Check brake hose for leakage. Repair if necessary. | | | ○ |
| Rear arm bearings* | S | Check for looseness. Adjust if necessary. | | ○ | ○ |
| Wheels * | S | Check balance/damage/out-of-roundness. Replace if necessary. | | ○ | ○ |
| Wheel bearings* | S | Check bearings assembly for looseness/damage. Replace if damaged. | | ○ | ○ |
| Steering bearings * | S | Check for looseness. Adjust if necessary. | ○ | ○ | Every 10 000 km |
| Suspension * | S | Check operation/oil leakage. Repair if necessary. | | ○ | ○ |
| Center stand, side stand | | Check operation. Repair if necessary. | ○ | ○ | ○ |
| Fittings / Fasteners * | S | Check all chassis fittings and fasteners. Adjust if necessary. | ○ | ○ | ○ |
| Battery * | | Check if voltage is over 12.8V. Charge if necessary. | | ○ | ○ |

*, S: It is recommended these items be serviced by official Linhai service.

⚠ NOTE

After **500 km or 1 month** of operation replace the engine oil to ensure that engine runs smoothly. Have the oil replaced by official Linhai dealer.

⚠ NOTE

Brake fluid replacement:

The brake fluid must be replaced when removing the master cylinder or caliper. Always check the brake fluid level. Refill if necessary.

Replace brake fluid seals of the master cylinders and brake calipers every 2 years.

Replace brake hoses every 4 years or immediately if they are damaged.

Have all maintenance and repairs performed at an authorized Linhai dealer.

